

SOLIMPEKS
Renewable Heating

Solimpeks Enameled Boiler Installation and User Manual



Enameled Boiler



INDEX

- 01 Meaning of Warnings and Symbols
- 02 Product Introduction
- 03 Warranty Coverage
- 04 Important Warnings
- 05 Putting into operation
- 06 Carrying and Placement of the product
- 07 Maintenance and Repair
- 08 Product range
- 09 200 L Enameled Boiler Connection Diagram
- 10 300 L Enameled Boiler Connection Diagram
- 11 Equipment - Electric Heating Resistances
- 12 Fault Detection

Information

This symbol indicates user tips and particularly useful information



DANGER

It indicates a possible dangerous situation.
Failure to observe the warning may result in serious injury or death.



ATTENTION

Indicates a possible warning or caution situation.



CENTER OF GRAVITY

The center of gravity of the load. If the center of gravity does not correspond to the geometric center of gravity, this mark is applied.



ELECTRIC CURRENT

It may cause death or injury.



RECYCLING

Symbol indicating whether the packaging is recyclable or recovery.



Risk of burn or injury.





The symbol indicates that you should protect the material inside the package from moisture.





Solimpeks is a company that produces 1st class quality boilers using manufacturing methods supported by high technology.

When it comes to the use of renewable energy, the choice of the hot water storage tank is crucial. Solimpeks product models are very practical to use thanks to their high energy efficiency and space-saving design.

 Solimpeks enamel boilers designed by utilizing different heat sources (solar, heat pump, etc.) are high performance products. Also available as an option as well as electrical energy equipment that our users can benefit from are offered to our users.

 The hot water stored in the tank is used as domestic water. Rated volume of the boiler, is the volume occupied by the domestic water in the tank.

 Heater fluid heated in a heat source, heat source and boiler with the help of circulation pump between the serpentine. The heating fluid transfers the heat it receives from the heat source into the boiler. This heat source can be a solar collector and/or a gas, liquid or solid fuel boiler.

 The inner surface of the Solimpeks boiler is coated with enamel. Enameling means coating the inner surface of the sheet with glass. Thus, domestic water can be stored under extremely hygienic conditions.

 Solimpeks Boiler is protected with magnesium anode rod in order to prevent the damages of cathodic corrosion. The magnesium anode rod must be changed by an authorized service center every 12 months after the boiler is commissioned. The magnesium anode rod is removable. The replacement of the magnesium anode rod must be carried out according to the operation sequence written in the installation manual.

 Solimpeks boiler products are 30-60mm in 50-500 liters to minimize heat losses High strength rigid polyurethane insulation material with a thickness of 40 kg/m³ density is being used.

If the heat output of individual DHW boilers is not sufficient, more boiler modules can be connected together.

It takes up little space as it is mounted vertically. Thanks to the fixed legs on it, there is no need to make a separate coffee table.

Solimpeks boiler products are manufactured in accordance with standards. However, improper use can cause serious injury or property damage.

In the factory, all equipment in the boiler is checked and tested against leaks according to the standards.

This booklet, which has been prepared for the Solimpeks branded product you have preferred, contains information on the use and maintenance of the product, as well as introductory and technical data about the product, summarized information on installation and putting into operation.

Please read this booklet before you start using the product and keep it for future reference.

Provided that the principles, warnings and standards specified in the user manual are complied with, your device is under Solimpeks warranty.

The warranty period starts from the date of delivery of the device and lasts for 5 years. Electrical device failures are only covered by a 1-year warranty.













Automatic control failures are only covered by a 1-year warranty.















The product warranty provided by Solimpeks does not cover malfunctions arising from the failure to use the device under normal conditions of use.

Malfunctions, problems and damages that may occur under the following conditions will not be covered by the warranty.

- If any operation is not carried out by the authorized service in accordance with the installation manual in case.
- Installation, putting into operation, use and maintenance conditions, failures caused by not fulfilling the responsibilities of the customer specified in the user manual.
- Failures and damages caused by improper storage and environmental conditions by the customer.
- Malfunctions that may occur in the device in case of wrong connection while making the electrical connection of the boiler.
- Failure to comply with the technical specifications (water pressure, voltage value, fuse value, grounding, etc.) specified in the user manual to ensure standard and trouble-free operating conditions of the device, fixed failures and problems that may occur in the device if it is absent or variable.
- Due to the failure of the consumer to perform periodic maintenance and controls on time malfunctions that may occur on the product.
- Failures caused by applications installed as open system, (corrosion and sediment formation, freezing of the system).
- Failure to provide adequate frost protection and damage caused by freezing of the system.
- Natural disasters (fire, flood, earthquake, hail, etc.) and external/physical external factors not caused by the product.
- Errors arising from the user's failure to perform periodic maintenance and controls.
- In the case that the original serial number, which must be found on the product, is erased or worn out.

IMPORTANT WARNINGS

-  The chemical imbalance of the water supply can lead to reduced heating efficiency of the storage tank and related equipment. It is important to check the water chemistry before installing the storage tank as the water quality will affect the reliability of the system. -
-  Lime formation in the boiler can shorten the service life of the tank. In addition, the formation of a lime layer in the tank will cause a decrease in liter capacity.
-  It is recommended that the pH value of the materials used in the heating system should be between 8.2 and 10.
-  Safety and energy savings are important factors to consider when choosing the water temperature setting of an electric heater thermostat. The thermostat setting should be adjusted according to the place of use. -
-  The electric heater may make some noise during operation. If the sound level becomes excessively loud, the electric heater needs to be cleaned. -
-  If the water temperature is above 60°C, there is a risk of scalding. For this reason, by installing a mixing valve in the system, the domestic water temperature can be adjusted and limited to 35-60°C.
-  A safety valve must be installed on the domestic water side of the boiler to provide 6 Bar pressure relief. The relief valve must be discharged into a suitable drain. -
-  Before manually operating the boiler from the safety valve drain valve on the domestic water side, make sure that no one comes into contact with the hot water coming out of this valve. This is because the water may be hot enough to pose a scalding hazard. To avoid injury or damage, the water should be directed to a suitable drain.
-  Water may drip from the safety valve drain pipe on the boiler and this pipe must be left open to the atmosphere. The pressure relief valve should be operated regularly to remove lime deposits and verify that it is not blocked. The discharge pipe of the pressure relief valve must be installed in a continuously downward and frost-free environment.
-  If the mains water pressure in the area where the boiler is installed is equal to or exceeds 6.5 Bar with fluctuations or continuously, a pressure reducer must be installed on the boiler mains water inlet line and the pressure regulator must be adjusted so that the outlet pressure value is maximum 6 Bar.
-  If the boiler will not be used for a long time and will be removed from the system, all connection points should be closed and protected against corrosion.
-  Boiler product groups should not be kept in places where they will be directly exposed to sunlight for too long. -
-  Boiler product groups must be installed in a frost-proof manner.

-  Please read this manual carefully before starting the installation.
-  The connection and mechanical installation of your device must be carried out by authorized persons in accordance with the relevant product connection diagram specified in this manual.
-  Remove the packaging. Dispose of the packaging in an environmentally safe manner. When removing the packaging around the product, hard and sharp objects should not be used to prevent damage to the insulation material.
-  The weight of the boiler must be suitable for the strength of the floor of the room where it will be installed. You can find the weight of the product you have purchased in the table of boiler weights in this booklet.
-  To keep heat losses as low as possible, the connection pipes between the storage tank and the user should be insulated and as short as possible.
-  Hot water pipelines should be insulated to prevent heat losses. Thermal insulation should be applied in accordance with country-specific instructions. Solimpeks recommends an insulation thickness of at least 9 mm.
-  In installations where the distance between the boiler and the user faucet is too long, it should be preferred to install a recirculation line. In an installation with a recirculation line, the user does not have to wait for the hot water from the boiler to circulate through the pipes when he opens the tap. Since the pump to be used in the recirculation line will circulate the domestic water, a pump with a bronze body should be used for hygiene. The recirculation line should be constructed as shown in the installation diagrams. -
-  In the Solimpeks boiler product range, the sensor sleeves are placed at the most suitable levels for the temperature distribution in the tank. Install the sensors as shown below in the locations indicated for each product without starting the system. -
-  After the mechanical installation connections are made in accordance with the boiler connection diagram, make sure that the system is completely filled with water and there is no air inside. Air valves must be installed at the highest points to prevent air in the system and boilers. -
-  A safety valve must be installed on the domestic water side of the boiler to provide 6 bar pressure relief. The relief valve must be discharged into a suitable drain.
-  It is mandatory to use a maximum 6 bar safety valve and an appropriate expansion tank according to the region to be installed for the solar energy line.
-  If there is an electric heater in the boiler product group, have electrical work done by qualified persons. Never operate the electrical components when the appliance is empty.
-  Before starting work on live parts, they must be disconnected from voltage and secured against accidental operation.
-  After finishing the connection of the product, the product and the mechanical installation should be checked for any leakage.
-  The functionality of the recommended installation materials should be tested periodically.

CARRYING AND PLACEMENT OF THE PRODUCT



The shipped products are shipped in the box and packaging so as to be minimally affected by external weather conditions. is being carried out.



We recommend delivering the product directly to the installation site on the pallet and in the original packaging.



When receiving the product, check that it is the model you ordered and that it was not damaged during shipment. You can have it.



Identify the damaged product or missing parts from the accessories shipped with the product notify the authorized dealer.



Solimpeks boiler product groups are heavy, so care should be taken when carrying the product to the place where it will be installed. You can find the weight of the product you have purchased in the table of boiler weights in this booklet.



You can unload the product to the installation site by a vehicle suitable for the tonnage of the product. When transporting with cranes and similar equipment, it should never be carried tightly with ropes over the boiler. The ropes can damage the insulation on the boiler and damage it.



The risk of tipping increases when lifting the storage tank on a wooden pallet and during transportation on a pallet truck or wheelbarrow. Therefore, take appropriate safety precautions to prevent tipping over.



The place where the product will be placed should be strong enough to support the weight of the device and the device should be placed on a flat surface.



During device assembly, necessary areas should be left where service personnel can intervene in case of malfunction or change.



Our company is responsible for the inefficient operation of the boiler due to errors such as transportation and placement of the product or physical accepts no responsibility for any damage.



Do not use cutting and piercing tools



i The anode rod should be replaced periodically every 12 months after the boiler is commissioned. This should be done by an authorized service center.

i In the boilers, water entry to the boiler is prevented by closing the valve at the mains water line inlet. Drain 5-10 liters of water from the drain line that should be connected to the boiler water inlet line. Replace the old anode rod with the new one.

i Boilers should be cleaned periodically by an authorized service. The cleaning cover for 200-300 lt capacities is on the side of the boiler. Boiler cleaning cover dimensions are designed in accordance with EN.

i After the boiler starts to operate, lime will be coated on the boiler coils over time depending on the rate in the water. Due to the lime coating of the serpentines, heat transfer will become difficult and will decrease the boiler efficiency over time. Therefore, the coil should be cleaned periodically through the cleaning covers.

i This cleaning should be done by an authorized service center. The enamel layer on the tank body and the coil must not be damaged.

i The flange on the boiler should only be disassembled or assembled by the authorized service. If the flange has been disassembled for cleaning or anode rod replacement, the bolts should be tightened in the order 1-4, 2-5, 3-6 for reassembly.

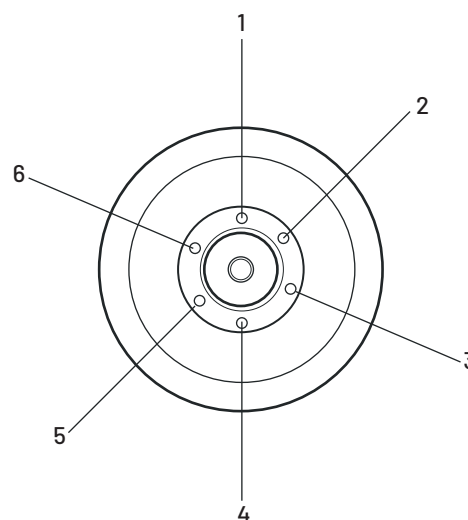
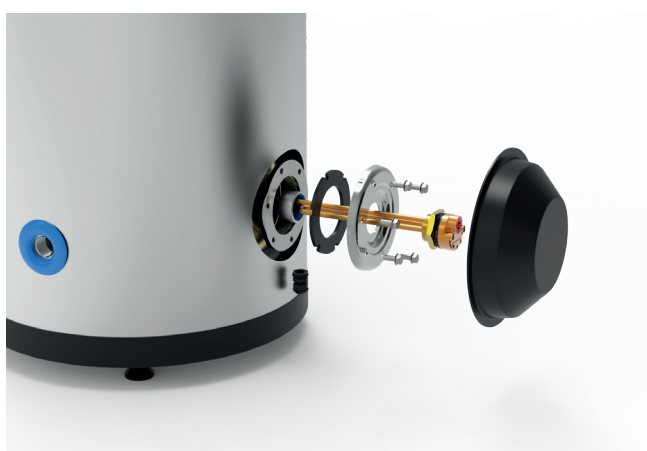

Enamel Coated Boliers

GENERAL INFORMATION

- ✓ Expanded serpentine surface area, designed for heat pumps.
- ✓ The inner surfaces of the boiler are advanced technology enamel coating.
- ✓ 200-400 µm enamel thickness.
- ✓ Electrostatic painted galvanized steel body.
- ✓ All surfaces in contact with clean water are hygienic and smooth, which does not allow bacterial growth.
- ✓ It is used for the preparation and storage of hot water together with solar collectors and heat sources.
- ✓ Produces fast hot water thanks to the expanded coil.
- ✓ Polyurethane with high quality insulation.

TSE-V 200 FOR HEAT PUMP PRO

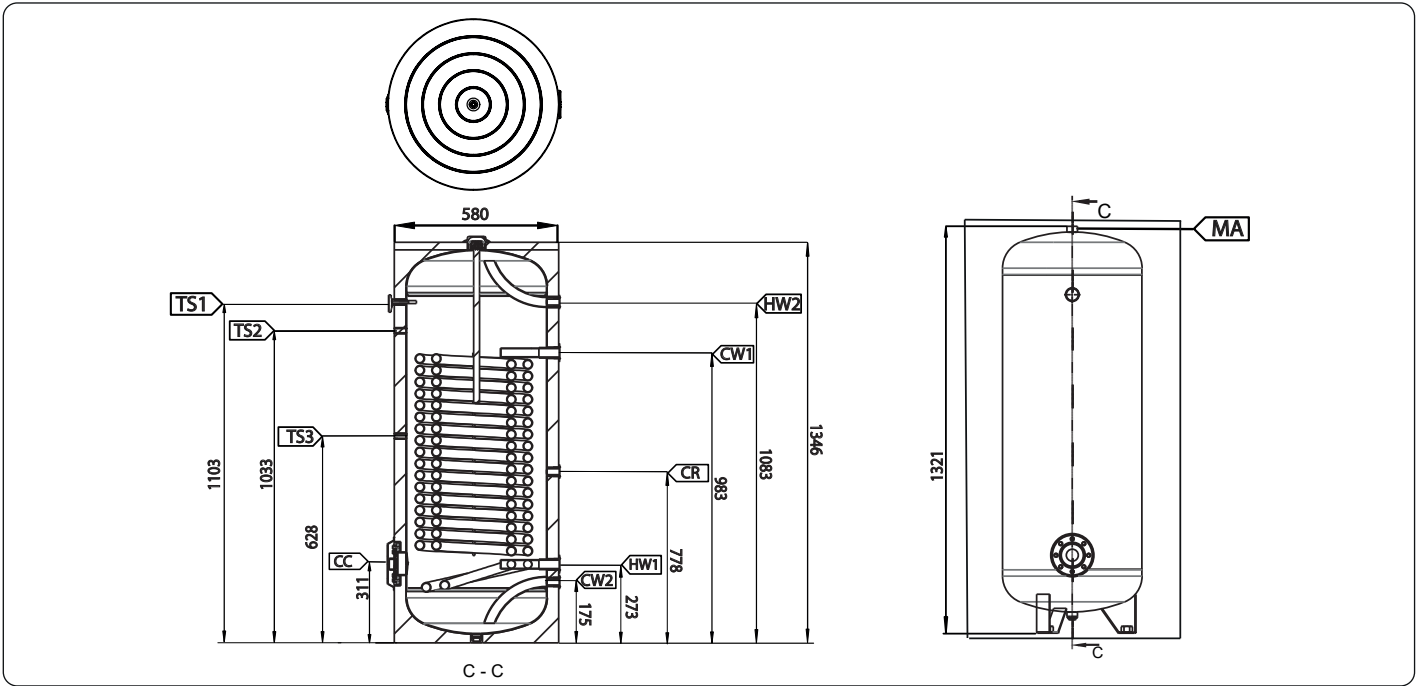

Pipe Connection

HW1	Hot Water Outlet	inch	G 1 1/4 "
CW1	Cold Water Inlet	inch	G 1 1/4 "
MA	Magnesium Anode	inch	G 1 1/4 "
EE	Electrical Heater	inch	G 1 1/2 "
TS1	Thermo Sensor	inch	G 1/2 "
TS2	Thermo Sensor	inch	G 1/2 "
TS3	Thermo Sensor	inch	G 1/2 "
CR	Circulation Return	inch	G 3/4 "
HW2	Hot Water Outlet (Domestic Water)	inch	G 3/4 "
CW2	Cold Water Inlet (Domestic Water)	inch	G 3/4 "
CC	Cleaning & Control Flange	mm	Ø100

Weights

Full Weight	kg	288
Empty Weight	kg	105

Dimensions

Height	mm	1346
Width	mm	580

Limits Of Use

Max. Working Pressure	bar	10
Test Pressure	bar	15
Max. Permissible Temperature	°C	95

Heat Exchanger

Surface Area	m ²	2,6
Max. Working Pressure	bar	6

Energy Efficiency Class

Class		B
Heat Loss S	W	57,3
Tank Volume V	L	183
Standby energy consumption / 24 hours	kWh	1,37
Insulating Material		PU 50mm

SCHEMATIC DIAGRAM OF INSTALLATION

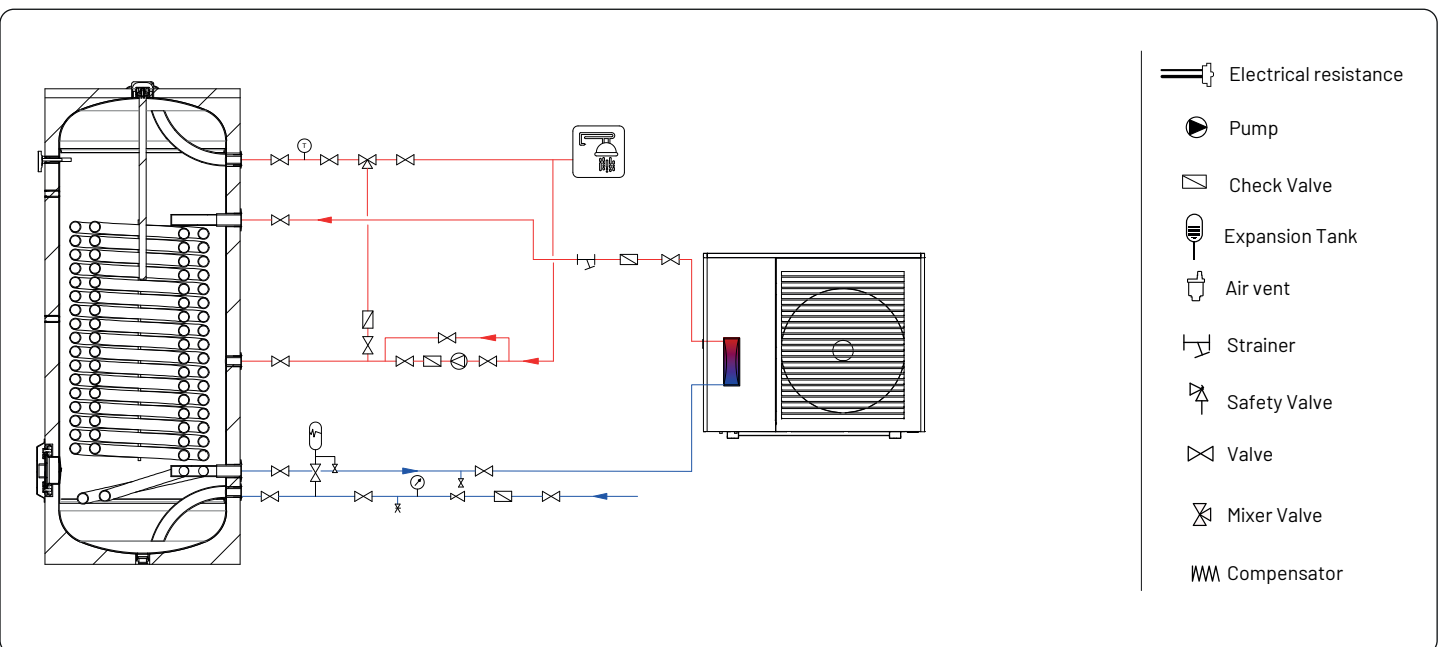

TSE-V 300 FOR HEAT PUMP PRO

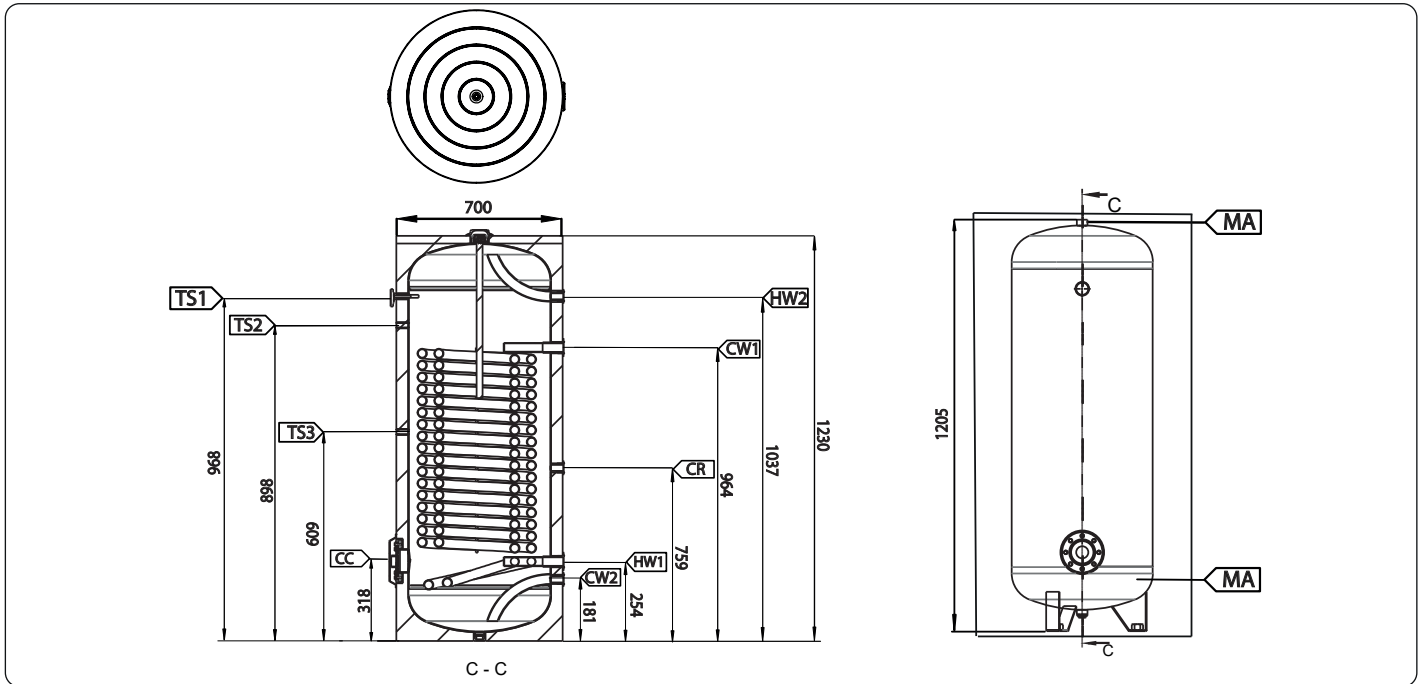

Pipe Connection

HW1	Hot Water Outlet	inch	G 1 1/4 "
CW1	Cold Water Inlet	inch	G 1 1/4 "
MA	Magnesium Anode	inch	G 1 1/4 "
CR	Circulation Return	inch	G 1 "
HW2	Hot Water Outlet (Domestic Water)	inch	G 1 "
CW2	Cold Water Inlet (Domestic Water)	inch	G 1 "
EE	Electrical Heater	inch	G 1 1/2 "
TS1	Thermo Sensor	inch	G 1/2 "
TS2	Thermo Sensor	inch	G 1/2 "
TS3	Thermo Sensor	inch	G 1/2 "
CC	Cleaning & Control Flange	mm	Ø100

Weights

Full Weight	kg	392
Empty Weight	kg	133

Dimensions

Height	mm	1230
Width	mm	700

Limits Of Use

Max. Working Pressure	bar	10
Test Pressure	bar	15
Max. Permissible Temperature	°C	95

Heat Exchanger

Surface Area	m ²	3,7
Max. Working Pressure	bar	6

Energy Efficiency Class

Class		C
Heat Loss S	W	86,4
Tank Volume V	L	259
Standby energy consumption / 24 hours	kWh	2,07
Insulating Material		PU 50mm

SCHEMATIC DIAGRAM OF INSTALLATION

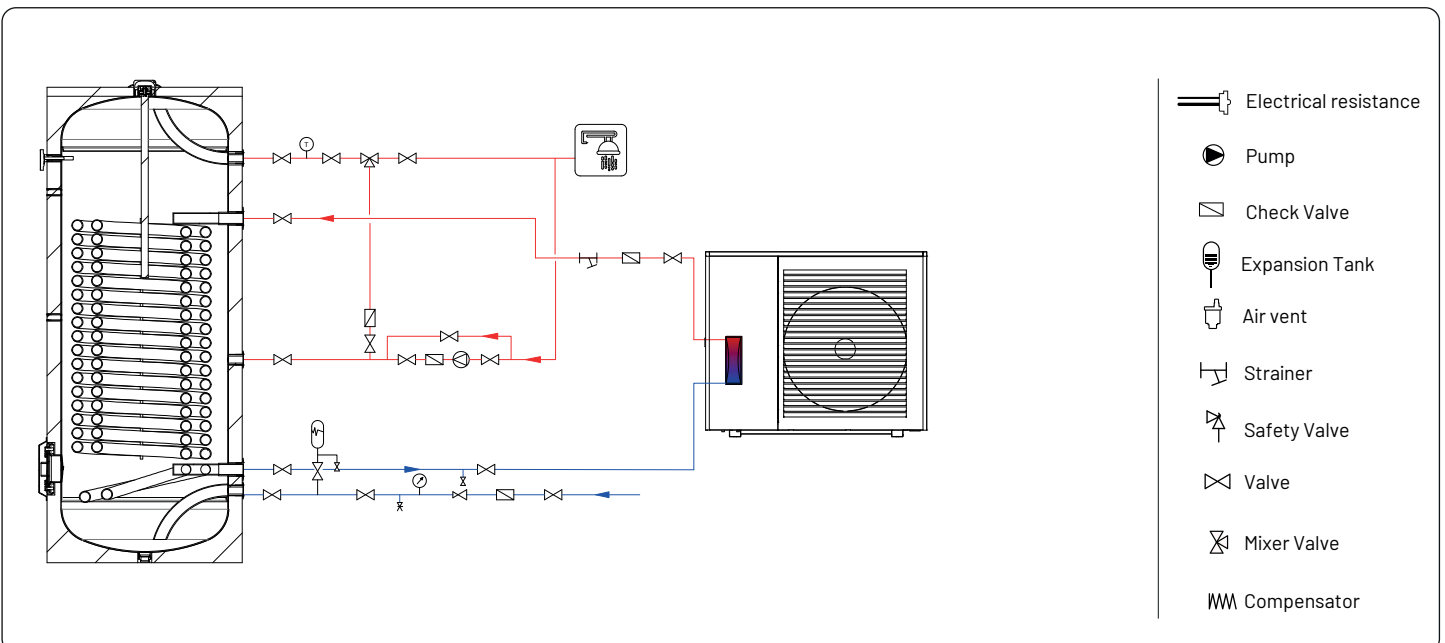

TSE-V 500 FOR HEAT PUMP PRO

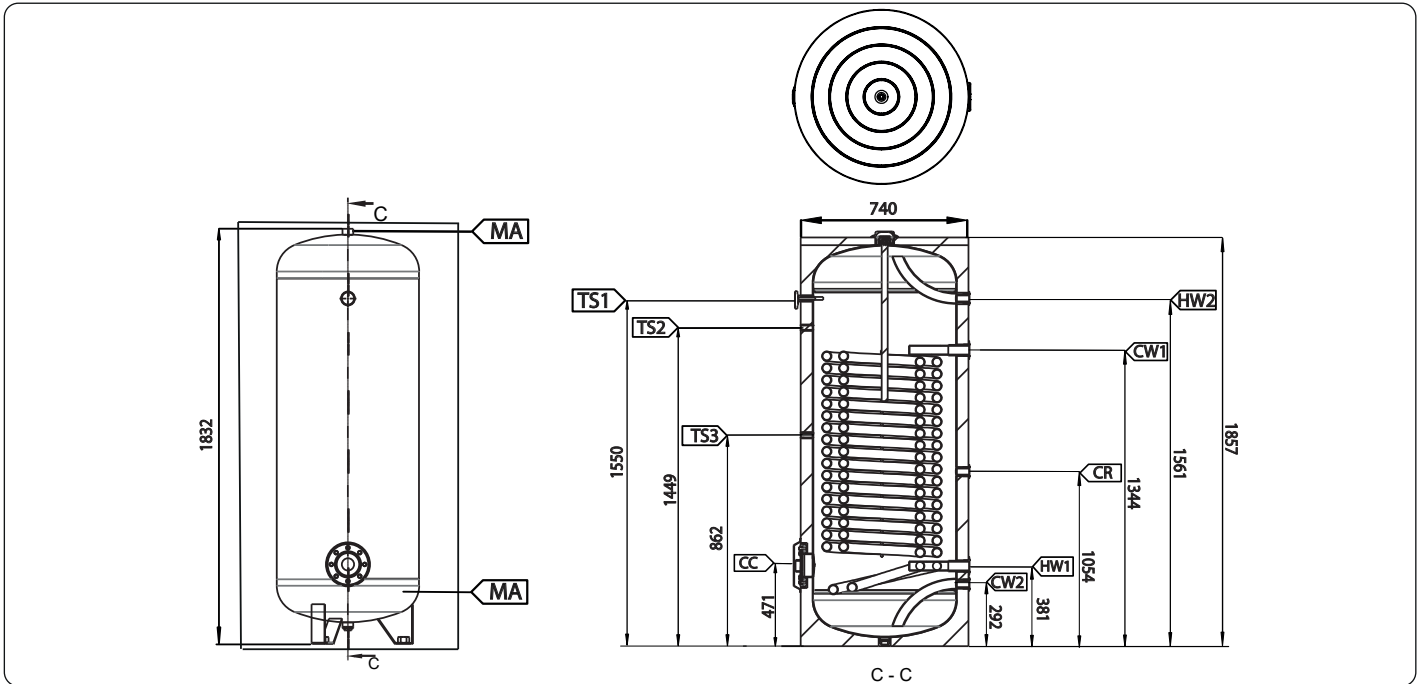

Pipe Connection			
HW1	Hot Water Outlet	inch	G 1 1/4 "
CW1	Cold Water Inlet	inch	G 1 1/4 "
MA	Magnesium Anode	inch	G 1 1/4 "
EE	Electrical Heater	inch	G 1 1/2 "
HW2	Hot Water Outlet (Domestic Water)	inch	G 1 "
CW2	Cold Water Inlet (Domestic Water)	inch	G 1 "
CR	Circulation Return	inch	G 1 "
TS1	Thermo Sensor	inch	G 1/2 "
TS2	Thermo Sensor	inch	G 1/2 "
TS3	Thermo Sensor	inch	G 1/2 "
CC	Cleaning & Control Flange	mm	Ø100
Weights			
Full Weight		kg	695
Empty Weight		kg	195
Dimensions			
Height		mm	1857
Width		mm	740

Limits Of Use		
Max. Working Pressure	bar	10
Test Pressure	bar	15
Max. Permissible Temperature	°C	95
Heat Exchanger		
Surface Area	m ²	5,2
Max. Working Pressure	bar	6
Energy Efficiency Class		
Class		C
Heat Loss S	W	112,1
Tank Volume V	L	492
Standby energy consumption / 24 hours	kWh	2,69
Insulating Material		PU 50mm

SCHEMATIC DIAGRAM OF INSTALLATION

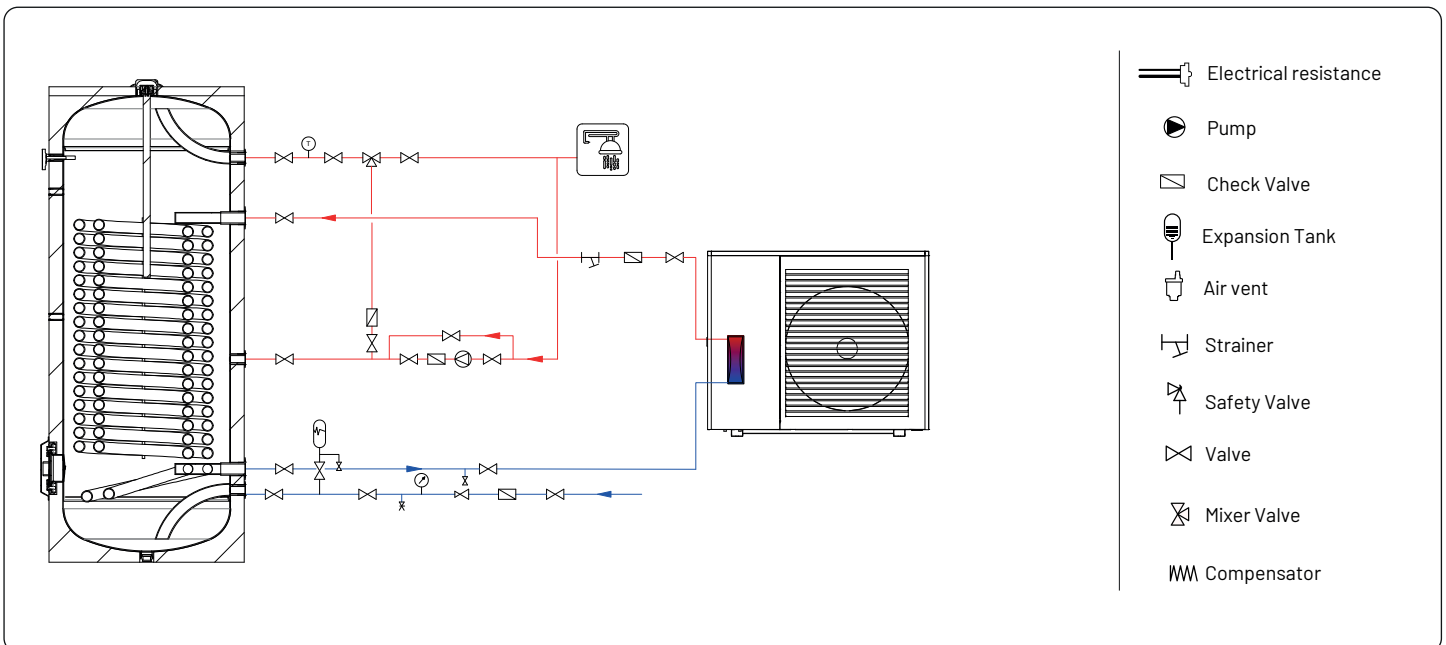

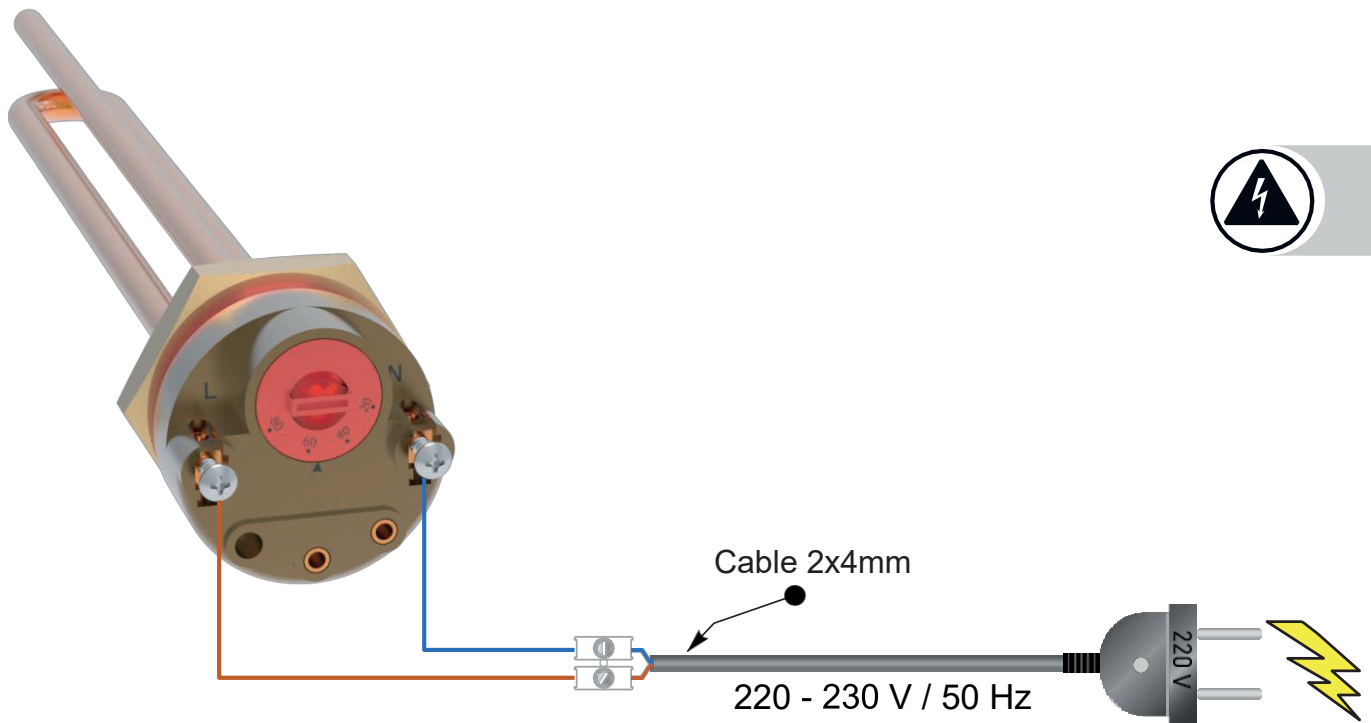

Type	Features
Operating voltage	220 - 230 V / 50 Hz
Heating capacity	3 kW
Heat field	30-70°C
Cable length	—
Heating rod length	25 cm
Screw threads	R 1 1/4"
Compliance	All products

- Touching live parts can result in electric shock, causing life-threatening injuries and may cause burns.
- Before working on live parts, they must be disconnected from the power supply (switch off fuses, main switches) and secured against accidental activation.
- The electrical installation must only be carried out by qualified electrotechnical personnel in accordance with the
- The electrical connection is not to the electric heater. Connection must be made to the thermostat.

Important Notice

The texts and illustrations in this manual have been prepared with the maximum possible care and the latest information. However, since it is impossible to avoid mistakes, we would like to point out the following points. Your project must always be based on your own calculations and planning in accordance with the applicable norms and instructions. We can give no guarantee that the illustrations and text published in this guide are complete, the descriptions herein are illustrative only. The use or application of the contents provided is in these cases at the sole risk of the respective user. The publisher cannot be held liable for inappropriate, incomplete or inaccurate information and any damage caused thereby.

Notes

Design and specifications are subject to change without prior notice. Images may differ from the models produced.

Imprint

Use of this installation and operating manual in whole or in part is protected by copyright. Any use outside of copyright is subject to the permission of SOLIMPEKS. In particular, this includes the reproduction/copying, translation, microfilming and electronic storage of this manual.

ADDRESS	: Fevzi akmak Mah. 10753. Sk. No: 3 Karatay / KONYA
TELEPHONE	: +90 332 444 06 02
FAX	: +90 332 444 06 08
E-MAIL	: info@solimpeks.com
WEB	: www.solimpeks.com