



SOLIBUFFER 300



Table of Contents

1.	General Information	3
1.1.	Symbols and Their Meanings	3
1.2.	Units of Measurement	3
1.3.	Valid Documents	3
2.	Intended use and introduction of the product	3
2.1.	Intended Use	3
3.	Shipment and placement of the product	4
4.	Assembly	4
4.1.	Product Setup	4
4.2.	Heating Circuit Connection	4
4.3.	Place Heating Connection	5
4.4.	Sensor Connection	5
4.5.	Installing the Safety Valve	5
4.6.	Installing the Air Release Valve	5
5.	Start-Up	5
6.	Maintenance & Cleaning	5
7.	Troubleshooting	6
8.	Technical Data	7
9.	Warranty Coverage	8
9.1.	Warranty Statement and Warranty Conditions	8
9.2.	Warranty Period	8
9.3.	Content and Scope of the Warranty	8
9.4.	Use of Warranty	8
10.	Environment and recycling	8

1. General Information

Read this booklet carefully before you start using the product and keep it so that you can refer to it later when necessary.

1.1. Symbols and Their Meanings

 It points out tips and especially useful information for the user.

 Indicates a possible dangerous situation. Failure to heed the warning could result in serious injury.

 Indicates a possible state of warning or caution.

 The use of pallet trucks is required during the transfer of the product. At the same time, the product must be safely put in place

 It may result in death or injury.

 It refers to whether the packaging is recyclable or recycled.

 It states that it complies with the security conditions within the framework of the technical legislation harmonization of the European Union.

 Protect the product from moisture.

 Risk of burns or scalds.

1.2. Units of Measurement

Unless otherwise stated, all dimensions are in millimeters.

1.3. Valid Documents

Instructions for use and installation of heat pump Valves in accordance with EN 1489
 Pressure relief valve according to EN 1489
 Check valves according to EN 13959
 Expansion tank in accordance with EN 1488

2. Purpose of Use and Introduction of the Product

2.1. Intended Use

The buffer tank hydraulically separates the heating circuit and the flows from the place. In addition, it stores excess energy and ensures that hot water is available for sudden demands.

One of the critical issues faced by heat pump systems is compressor stop-start cycles, which are often triggered by room thermostats. While these frequent on-off cycles can maintain indoor comfort, they can significantly reduce the efficiency of the heat pump and shorten its lifespan. To solve this problem, buffer tanks should be used.

Air source heat pumps, in particular, make great use of buffer tanks. These heat pumps often face icing problems during operation, which require defrosting cycles. Buffer tanks contribute to energy savings and system reliability by ensuring that the energy required for defrosting is not taken from the comfort of the home. The use of buffer tanks in heat pump systems is a practical solution to increase efficiency, extend the life of the system and maintain indoor comfort.

The product is intended for use in a domestic environment. It can be safely operated by untrained persons.

3. Product Shipment and Placement

 Products should be shipped in boxes and packaging that will be least affected by external weather conditions. (Figure 1)

We recommend that you deliver the product directly to the place of installation in the box and in the original packaging.

When receiving the product, check that it is the model you ordered and that it is not damaged during shipment.

Identify the damaged product or missing parts from the accessories shipped with the product and report it to the authorized dealer.

 The Solibuffer 300 product is heavy, so care should be taken when transporting the product to the place where it will be installed. You can find the weight of the product you have purchased in the boiler weights table (page 7) in this booklet.



(Figure - 1 Packaging of the product)

 You can lower it to the assembly place by means of a vehicle suitable for the tonnage of the product. When transporting with cranes and similar equipment, the product should not be carried tightly with ropes. Ropes can damage the product insulation by crushing it.

When lifting the storage tank over the wooden pallet, the danger of tumbling down increases. Therefore, take appropriate safety precautions to prevent tumbling down.

No responsibility is accepted for inefficient operation or physical damage to the product due to errors such as transportation and placement of the product.

 When assembling the product, necessary areas should be left where service personnel can intervene in the event of a malfunction or change (Figure 2).

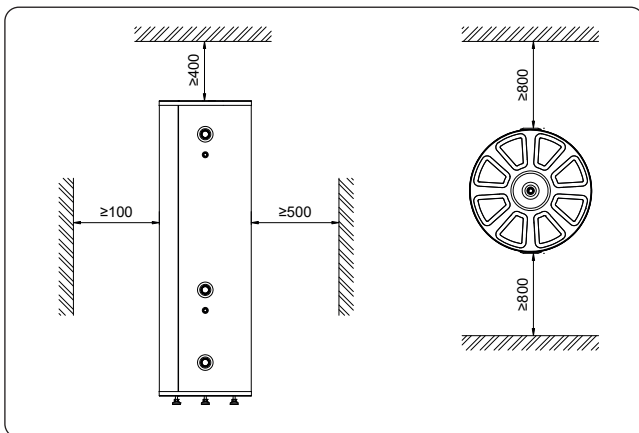

(Figure -2 minimum distances required for installation)

4. Assembly

4.1. Product Setup

 Please read this manual carefully before starting the installation.

 The connection and mechanical installation of the product should be carried out by authorized persons according to the relevant product connection diagram specified in Figure 6.

Remove the packaging. Dispose of the packaging in a way that does not harm the environment.

 When removing the packaging around the product, hard and sharp objects should not be used to avoid damage to the insulation material.

 The weight of Solibuffer 300 should correspond to the strength of the floor of the room in which it will be installed.

The chemical imbalance of the water supply can lead to a decrease in the heating efficiency of the storage tank and related equipment. It is important to check the water chemistry before installing the storage tank, as the water quality will affect the reliability of the system.

4.2. Heating Circuit Connection

 Assemble the piping (figure 6) as shown. In order to reduce heat losses, the pipes of the storage tank and the heating circuit (heat pump, boiler, etc.) should be insulated (at least 9 mm) and short.

4.3. Place Heating Connection

Assemble the place heating circuit as shown in Figure 6. In order to reduce heat losses, the connecting pipes between the storage tank and the place should be as short and insulated as possible. The insulation thickness must be at least 9 mm. A 3 bar safety valve must be installed in the place heating circuit (underfloor heating, fan coil, etc.).

4.4. Sensor Connection

In the Solibuffer 300 range, the sensor sleeve is positioned at levels that are optimally suited to the temperature distribution within the tank. As shown in Figure 5, the sensors must be installed without starting the system.

4.5. Installing the Safety Valve

If a safety valve is not installed on the heating or place line, a 6 bar safety valve must be installed on the tank. If it is necessary to operate the safety relief valve manually, make sure that no one comes into contact with the hot water coming out of the valve. Because the water can be hot enough to pose a scald hazard. To avoid injuries, the drain pipe should be installed downwards and in a frost-free environment.

4.6. Installing the Air Release Valve

After the mechanical installation connections are made in accordance with the connection diagram to the product, make sure that the system is completely filled with water and there is no air left in it. Install an air valve in the highest places so that there is no air left in the system and boiler.

When you fill the product with water, do not pressurize it. Finish the filling process after the flow is cut off from the air valve on the product.

5. Start Up



If there is an electric heater, have the electrical work done by qualified persons. Never operate electrical components when the product is empty.

Before starting work on electrically conductive parts, they must be disconnected from the voltage and secured against accidental starting.



In the event of a malfunction of the electrical heater connected to the product, it is recommended to install an electrical circuit breaker in accordance with EN 60730-2-9 to ensure that the heat input is cut off before the water temperature in the tank reaches 95 °C.



If there is an electric heater, safety and energy saving are factors that should be taken into consideration when choosing the water temperature setting of the thermostat. The thermostat setting needs to be adjusted according to the place of use.



After finishing the connection of the product, it should be checked whether there are any leaks in the product and mechanical installation.

6. Maintenance & Cleaning

Foreign objects such as rust or sealant adversely affect the operational safety of the product. In this case, you can empty the product and perform the cleaning process.

If you need to drain the product for maintenance or if there is a risk of freezing, follow the steps below.

- Close the shut-off valves on the supply lines.
- Connect a drain line to the drain valve.
- Relieve pressure by opening the relief valve.
- Remove the metal plug from the ventilation connector (AV).
- Empty the product completely.



Hot water may leak when emptying



The product. Use heat-resistant



Protective gloves.

The electric heater may make some noise when it is operating. If the sound level becomes excessively high, the electric heater needs to be cleaned. In this case, you can empty the product and perform the cleaning process.

7. Troubleshooting

When you encounter a problem, call the authorized person.

For better and faster assistance, tell the authorized person the serial number on the product label (figure 3).

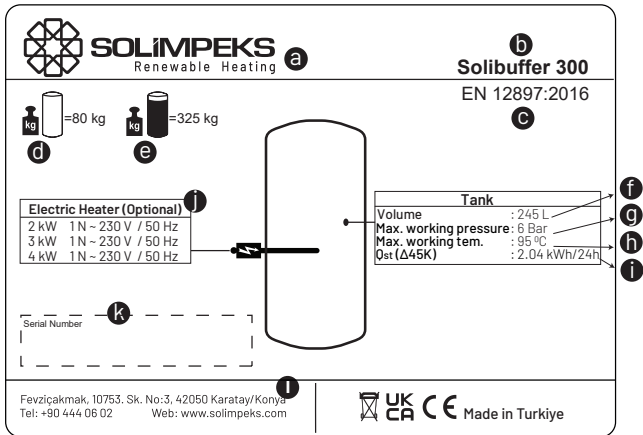

(Figure -3 product)

NO	MEANING
a	Manufacturer's name, trademark or promotional mark
b	Product Name
c	Number and year of production standard
d	Empty product weight
e	Full product weight
f	Rated storage volume
g	Highest design pressure on the heating side
h	Max. Operating Temperature
i	Constant heat loss in kWh/24h or W
j	Electric heater
k	Manufacturing number/serial number indicating the year of manufacture
l	Communication

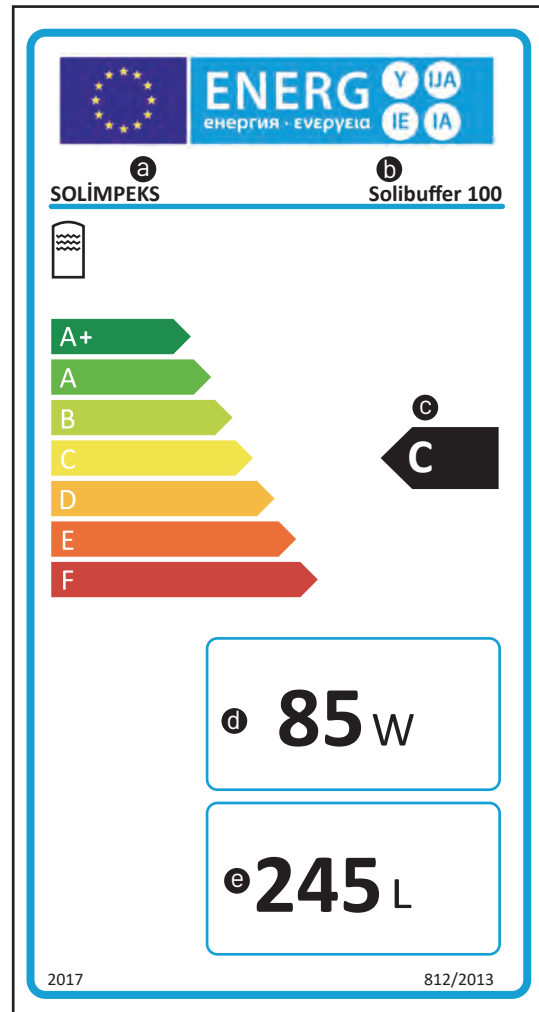

(Figure -4 energy class)

NO	ANLAMI
a	Manufacturer's name, trademark or promotional mark
b	Product Name
c	Energy class
d	Heat loss
e	Product volume

8. Technical Data

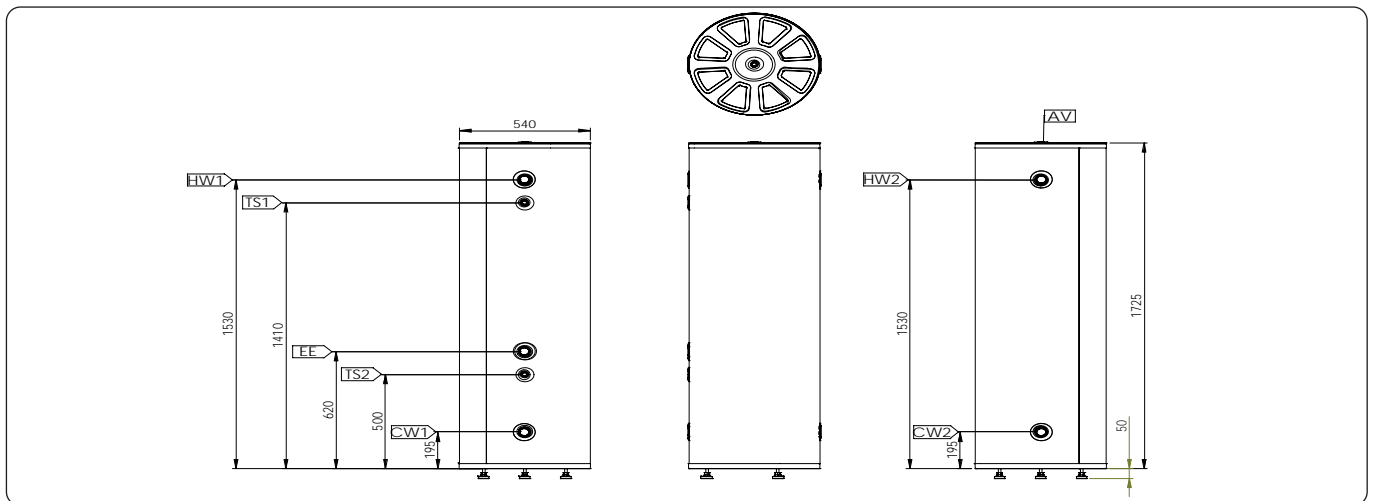

(Figure -5 technical drawing information of the product)

Pipe Connection			
HW1	Hot Water Outlet	inch	G 1 1/4"
TS1	Thermo Sensor	inch	G 1/2"
EE	Electrical Heater	inch	G 1 1/4"
TS2	Thermo Sensor	inch	G 1/2"
CW1	Cold Water Inlet	inch	G 1 1/4"
CW2	Heat Pump Cold Water Outlet	inch	G 1 1/4"
HW2	Heat Pump Hot Water Inlet	inch	G 1 1/4"
AV	Air Ventilation		G 1/2"

Limits of use		
Max. Working Pressure	bar	6
Test Pressure	bar	9
Max. Permissible Temperature	°C	95
Weights		
Full Weight	kg	325
Empty Weight	kg	80
Dimensions		
Height	mm	1725
Width	mm	540
Energy Efficiency Class		
Class		C
Heat Loss	W	85
Tank Volume	L	245
Standby energy consumption /24 hours at 65 °C	kWh	2.04

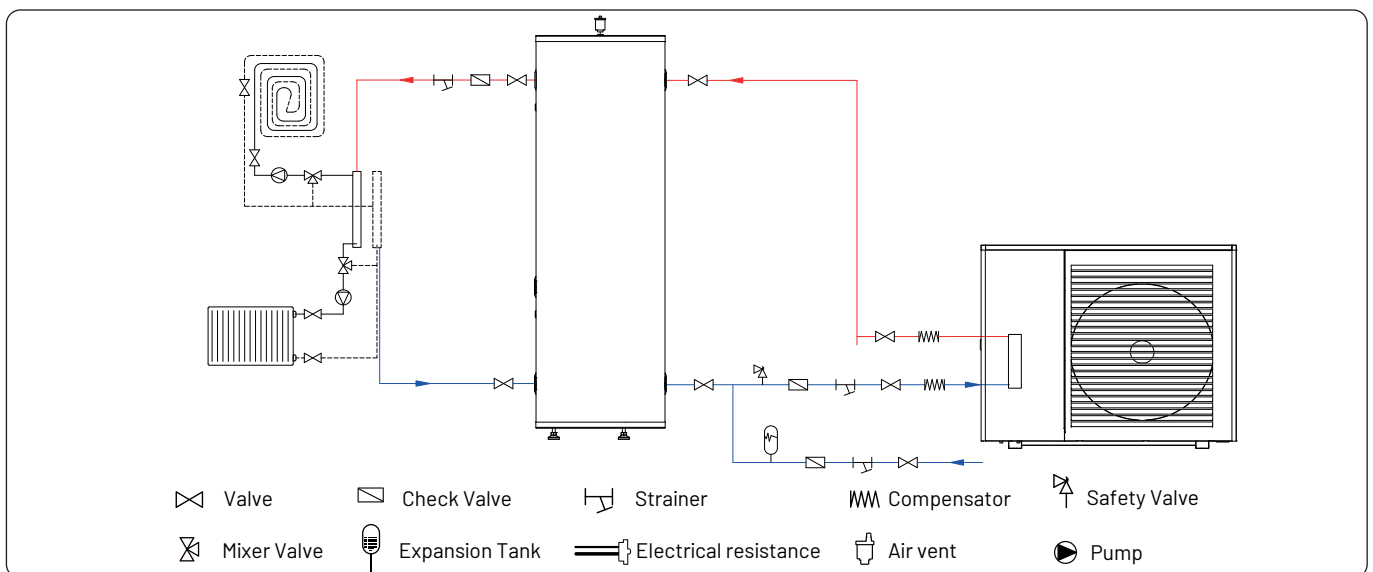

(Figure -6 installation diagram)

9. Warranty Coverage

9.1. Warranty Statement and Warranty Conditions

These warranty conditions hold the additional warranty services provided by us to the end customer. These apply in addition to the end customer's statutory warranty claims. Statutory warranty claims of the end customer against other contractual partners remain unaffected by our warranty. The exercise of these statutory warranty rights is free of charge. These rights are not restricted by our warranty.

9.2. Warranty Period

The warranty period for each product starts with delivery to the customer using the product and the warranty period is 5 years.

Electrical product failures are covered by the warranty for only 1 year.

9.3. Content and Scope of the Warranty

Warranty service is provided in the event of a manufacturing and/or material defect in our products during the warranty period. However, services for devices that are caused by malfunction, damage or defects due to calcification, chemical or electrochemical influences, improper assembly or installation, or improper adjustment, operation, use or improper operation are not covered by the warranty.



Malfunctions, problems and damages that may occur under the following conditions will not be covered by the warranty.

- If any operation is not carried out by an authorized service in accordance with the installation manual.
- Malfunctions caused by the conditions of installation, start up, usage and maintenance, non-fulfillment of the responsibilities of the customer specified in the user manual.
- Malfunctions and damages caused by improper storage and environmental conditions by the customer.
- Malfunctions that may occur in the product in case of incorrect connection while electrical connection of the product.

- Malfunctions and problems that may occur in the product if the technical specifications specified in the user manual (water pressure, voltage value, fuse rating, grounding, etc.) are not suitable, not fixed or variable in order to ensure the standard and trouble-free working conditions of the product.
- Malfunctions caused by applications installed as an open system (corrosion and deposit formation, freezing of the system).
- Damage caused by insufficient frost protection and freezing of the system.
- Natural disasters (fire, flood, earthquake, hail, etc.) and adventitious/physical external factors that are not caused by the product.
- Errors that may arise from the customer's failure to perform the maintenance and controls that should be done periodically.
- In case of erasure and wear of the original serial number on the product.

9.4. Use of Warranty

Warranty claims must be submitted to us before the warranty period expires, within two weeks of becoming aware of the defect. This request should include details of the fault, the product, and the time when the fault was detected. An invoice or other dated proof of purchase should be attached as a warranty certificate. If the above-mentioned information or documents are missing, any warranty claim cannot be demanded.

10. Environment and Recycling



Disposal of shipping and sales packaging materials; We have carefully packed your product to ensure that it arrives undamaged. Please help protect the environment and dispose of the packaging material of the appliance properly.

Important Warning

The texts and illustrations in this manual have been prepared with the maximum possible care and with the latest knowledge. However, since it is impossible to avoid errors, we would like to point out the following points.

Your project should always be based on your own calculations and planning in accordance with the applicable relevant norms and guidelines. We can make no guarantee that the drawings and texts published in this manual are complete, the descriptions here are for illustrative purposes only. In the use or application of the given contents, the risk is solely under the relevant user's responsibility. The publisher cannot be held responsible for inappropriate, incomplete or incorrect information and any damages that may arise in connection therewith.

Notes

Design and specifications are subject to change without notice. Pictures may differ from the models produced.

Colophon

The use of this installation and user manual, in whole or in part, is protected by copyright. Any use other than copyright is subject to the permission of SOLIMPEKS. This includes, in particular, this guide's duplication, translation, microfilming and saving in electronic systems.



ADDRESS	: Fevzi akmak Mah. 10753. Sk. No:3-3a Karatay/KONYA
TELEPHONE	: +90 332 346 38 41
FAKS	: +90 332 444 06 08
EMAIL	: info@solimpeks.com
WEB	: www.solimpeks.com