



# SOLIMPEKS

Renewable Heating

EN

[solimpeks.com](http://solimpeks.com)

**2026**



# T Z E T Z O C

03	COMPANY
04	HEADQUARTERS
05	COMPANY
06	CERTIFICATES
07	CERTIFICATES
08	PRODUCTION
09	QUALITY

## STORAGE TANKS

10-11	VARMBUFFER 4
12-13	VARMBUFFER 8
14-15	SOLIBUFFER
16-17	SOLITANK
18-19	SOLIKOMBI

## ENAMEL COATED TANKS

20-21	ENAMEL TSE-VA
22-23	ENAMEL TSE-VS
24-25	ENAMEL TSE-VS HP
26-27	ENAMEL TSE-VD

## SOLAR WATER HEATERS

28	TSM
29	TSE
30	TSM THERMOSIPHON SYSTEMS
31	TSE THERMOSIPHON SYSTEMS

## SOLAR THERMAL COLLECTORS

32	WUNDER ALS
33	WUNDER ANSG
34	WUNDER ANP
35	WUNDER ALS DRAIN
36	WUNDER ALS HORIZONTAL
37	WUNDER ALS EXCELL

## PV-T HYBRID PANELS

38	EXCELL 590 W
----	--------------

## PVARM

## HEAT PUMPS

40	VARM UP SERIES
41	VARM SILENT POOL SERIES

## SOLAR THERMAL ACCESSORIES

42	VARM ALL SERIES
43	ACCESSORIES

**SOLIMPEKS Enerji Paz. Ltd. Şti.**  
**IZMIR / TURKEY**



**Solimpeks Solarenergie GmbH**  
**HANNOVER / GERMANY**



● **HEADQUARTERS**

**KONYA / TURKEY**



# COMPANY

## ● COMPANY

The origins of Solimpeks date back to 1977. Through R&D and a strong focus on quality, company growth was accelerated and allowed Solimpeks to export in markets all over the world. As a consequence of this expansion Solimpeks now has a reputation as a world leading manufacturer of high-quality renewable heating products almost everywhere under the sun. The company is the world's leading manufacturer of hot water storage tanks, heat pumps, solar water heaters and pv-t hybrid collectors. Solimpeks employs over 300 staff in its locations across Turkey and Germany.



# ● MILESTONES

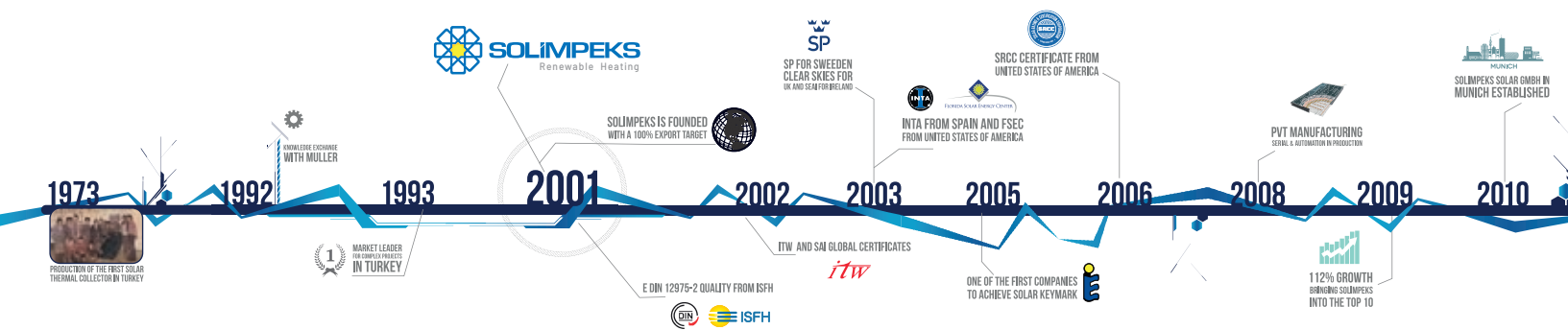

# ● CERTIFICATES



The "Solarkeymark"denotation, is issued by ESTIF and is throughout Europe, has become the most widely accepted certificate for solar thermal products, this has been made obligatory for all goods entering Germany since January 2007 and the favoured certificate to get refund incentive payments EU countries.



The Federal Office of Economics and Export Control (BAFA) is a superior federal authority subordinated to the Federal Ministry of Economics and Technology (BMWi) in Germany. A central task of BAFA in the foreign trade sector is export control. In the energy sector BAFA implements measures to promote a better use of renewable energies, the saving of energy, for the maintenance and extension of the power-heat-linkup and for German coal mining, and participates in crisis-contingency measures in the mineral oil sector.



The German "TÜV" (Technischer Überwachungs Verein) certificate.



SRCC provides authoritative performance ratings, certifications and standards for renewable energy products, with the intention of protecting and providing guidance to consumers, incentive providers, government, and the industry.



IEC (International Electrotechnical Commission) prepares International Standards for systems of photovoltaic conversion of solar energy into electrical energy and for all the elements in the entire photovoltaic energy system.



The "ISFH" (Institute für Solarenergieforschung) certificate issued by the Leibniz University Solar Energy Research Institute.



CSTBat; Worldwide accredited association that promotes the development of France through the culture of quality.



The "ITW" (Institut für Thermodynamik und Wärmetechnik) certification issued by the Thermodynamics and Heating Techniques Institute at Stuttgart University.



The SEAI (Sustainable Energy Agency of Ireland)



The "CE" (Conformité Européenne) approval certifying health and safety in Europe.



ISO 27001 Information Security Management System certificates; ISO 27001 Information security management system is established by an accredited certification organization to pass through 2 stages of supervision and to prove its continuity.

# MILESTONES



# CERTIFICATES



HYB; states that manufacturing facilities comply to Turkish Standards.



The Turkish Standards Compliance Certificate:  
This certification states that the authorized manufacturer's products comply with Turkish Standards.



The "INTA" (Instituto Nacional De Técnica Aeroespacial) award issued by the Spain's International Quality Institute,



Occupational health and safety management system.



The National Renewable Energy Centre is a technology center specialising in applied research, and the development and promotion of renewable energy. It is highly rated and has acknowledged national and international prestige.



The MCS certificates microgeneration technologies used to produce electricity and heat from renewable sources in the UK.



Worldwide accredited association that promotes the development of Italy through the culture of quality.



Eurofins Scientific is an international life sciences company which provides a unique range of analytical testing services to clients across multiple industries



Fraunhofer is Europe's largest application-oriented research organization based in Munich, GERMANY.



ISO 14001 Environmental Management System (EMS) provides a continuous cycle of planning, implementing, reviewing, and improving the processes and actions that are performed to meet business and environmental goals.



ISO 9001:2015 specifies requirements for a quality management system where an organization, needs to demonstrate its ability to consistently provide product that meets customer and applicable regulatory requirements.

# PRODUCTION



Solimpeks products are manufactured using the latest proven industry methods in order to ensure quality and the lowest failure rates. From robotic production lines with a high level of automation to custom-made product-specific machinery; all our products are manufactured in line with industry standards for quality. At the Solimpeks outdoor testing site, the solar products are subjected to extreme climatic and endurance tests. All of our manufactured products are subjected to above the standard requirements for testing, to ensure the products are of the highest quality before leaving our factory.

# QUALITY

At Solimpeks, Quality Assurance and Control processes are our main priority,

In this process, it ensures the production of products in accordance with standards with a quality-oriented approach in order to ensure customer satisfaction, meet customer expectations and create new customer portfolios.

In Solimpeks, all processes starting from the design of the products, through raw material purchasing, production, shipment and usage are carried out in accordance with the quality standards, product standards (EN 12897, EN 12975, ISO 9806, DIN EN 12975, DIN EN 12976-1/2, TS EN 12975, DIN 4753-3, EN 55014-1-2, EN 61000-3-11, EN 62233, EN 61000-3-12, EN 60335-1-2-40, EN 62233, EN 60204, EN 12100-1, EN 14276-1-2, EN 378-1-2-3-4, EN 14825, EN 14511, EN 14511-4, EN 12102-1, EN 61000-3-3, EN 61000-3-2, EN IEC 62311, ETSI EN 300 328) and EU directives (EMC Electromagnetic Compatibility Directive 2014/30/EU, LVD Low Voltage Regulation 2014/35/EU, MD Machinery Directive 2006/42/EC, PED Pressure Equipment Directive 2014/68/EU, ECO Design Directive 2009/125/EC EU 2016/2282:2016-11-30, Energy Labelling 2010/30/EU, RoHS Directive 2011/65/EU, ATEX Directive, RED Radio Equipment Regulation), HP KEYMARK (EU) No 813/2013 ) to ensure compliance with legal requirements, ISO 9001 Quality Management System and ISO 16949 Automotive Quality Management System are implemented.

The system documents we have are; ISO 9001 Quality Management System, ISO 14001 Environmental Management System, ISO 45001 Occupational Health and Safety Management System, ISO 50001 Energy Management System and ISO 27001 Information Security Management System. Our products are tested in accredited laboratories to ensure that they meet the standard requirements and these processes are crowned with certificates (Solarkeymark, ISO, SRCC, QB, TSE...) that are accepted as valid in many parts of the world.

It increases the quality of products delivered to the end user/customer by analyzing the risks in its processes and processes, preparing control plans, analyzing measurement systems according to the control plan and measurement methods, and preparing statistical process controls by statistically monitoring its processes. It also carries out quality studies and studies for different certification processes in customer-specific requests.

Solimpeks has adopted the principle of continuous improvement. It continues to work to continuously improve quality and all other processes through digitalization.



# VARMBUFFER 4



## GENERAL INFORMATION

- ✓ Varmbuffer Models is a buffer tank suitable for small-scale applications. The buffer enables hydraulic separation between the heat pump circuit and heating circuit flows. In addition, it stores excess energy and ensures that hot water is available for sudden demands.
- ✓ It protects your heat pump from the negative effects of short cycling. Short cycling not only leads to higher operating costs, but can also damage your heat pump, reducing its lifespan and overall energy efficiency performance.
- ✓ Polyurethane with high quality insulation.
- ✓ Vinlex - Artificial Leather outer cover.
- ✓ It can be mounted to the wall.
- ✓ Easy installation thanks to its compact design.
- ✓ Minimum maintenance.



Varmbuffer		25	50	80	100
Capacity	L	28	50	77	105
Net weight	kg	11	17.5	22.5	25
Insulation / (Polyurethane 40kg/m <sup>3</sup> )	mm	30	30	30	30
Maximum operational temperature	°C	95	95	95	95
Rated pressure	bar	6	6	6	6

Pipe Connection			
C1, C2	Cold water in	inch	IG 1"
H1, H2	Hot water out	inch	IG 1"
A	Venting	inch	IG 1/2"
E	Emptying	inch	IG 1/2"

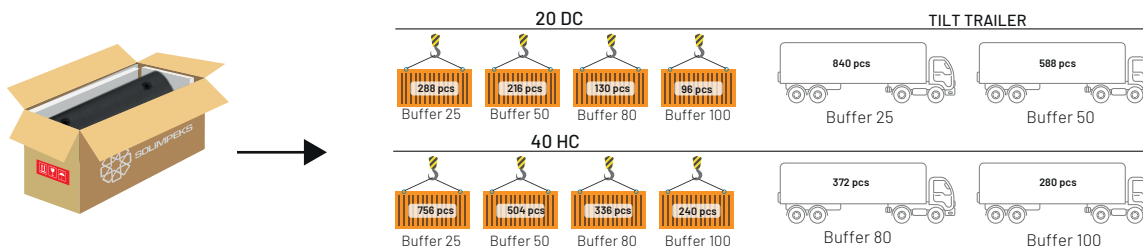

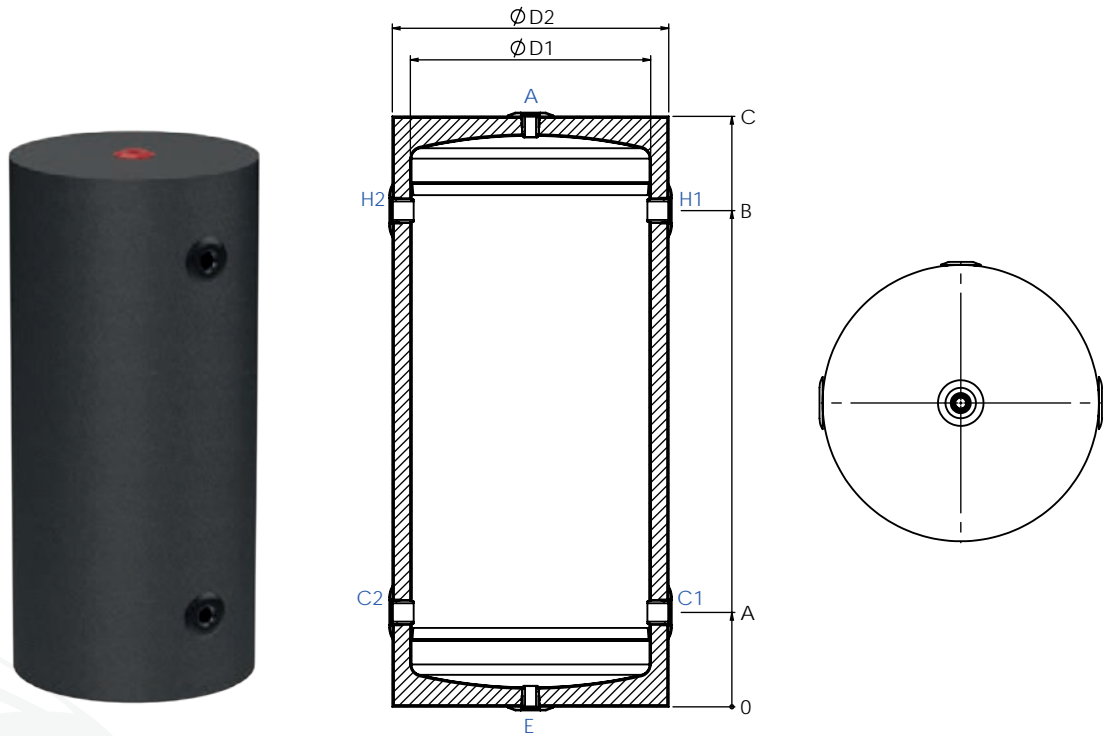

DIMENSIONS					
Varmbuffer	A	B	C	D1	D2
25	128	528	655	250	310
50	125	795	920	280	340
80	155	1065	1220	304	364
100	155	815	970	394	454

**SCHEMATIC DIAGRAM OF INSTALLATION**

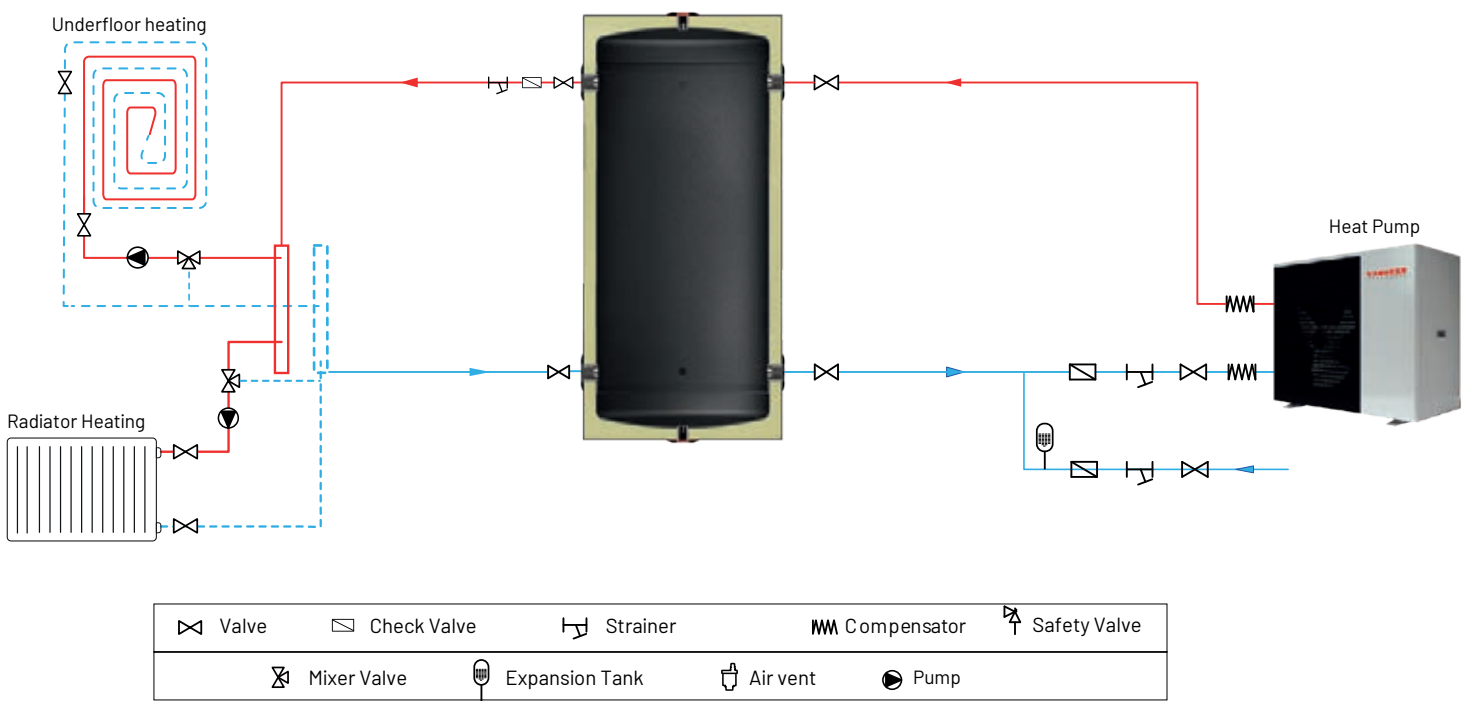

# VARMBUFFER 8



## GENERAL INFORMATION

- ✓ Varmbuffer Models is a buffer tank suitable for small-scale applications. The buffer enables hydraulic separation between the heat pump circuit and heating circuit flows. In addition, it stores excess energy and ensures that hot water is available for sudden demands.
- ✓ It protects your heat pump from the negative effects of short cycling. Short cycling not only leads to higher operating costs, but can also damage your heat pump, reducing its lifespan and overall energy efficiency performance.
- ✓ Polyurethane with high quality insulation.
- ✓ Vinlex - Artificial Leather outer cover.
- ✓ It can be mounted to the wall.
- ✓ Easy installation thanks to its compact design.
- ✓ Minimum maintenance.



Varmbuffer		50	80	100
Capacity	L	50	77	105
Net weight	kg	18	23.5	25.5
Insulation / (Polyurethane 40kg/m <sup>3</sup> )	mm	30	30	30
Maximum operational temperature	°C	95	95	95
Rated pressure	bar	6	6	6

Pipe Connection			
C1, C2, C3, C4	Cold water in	inch	IG 1"
H1, H2, H3, H4	Hot water out	inch	IG 1"
A	Venting	inch	IG 1/2"
E	Emptying	inch	IG 1/2"

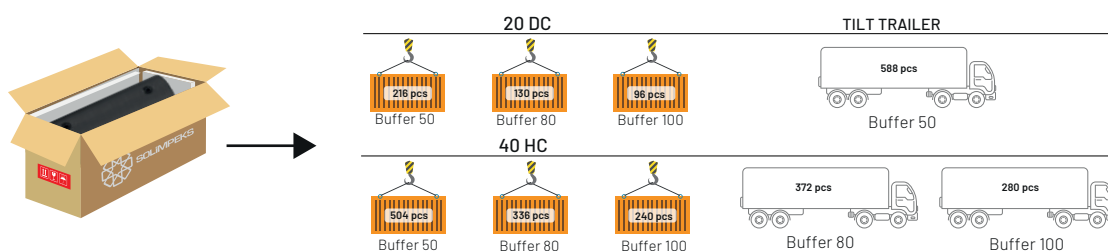

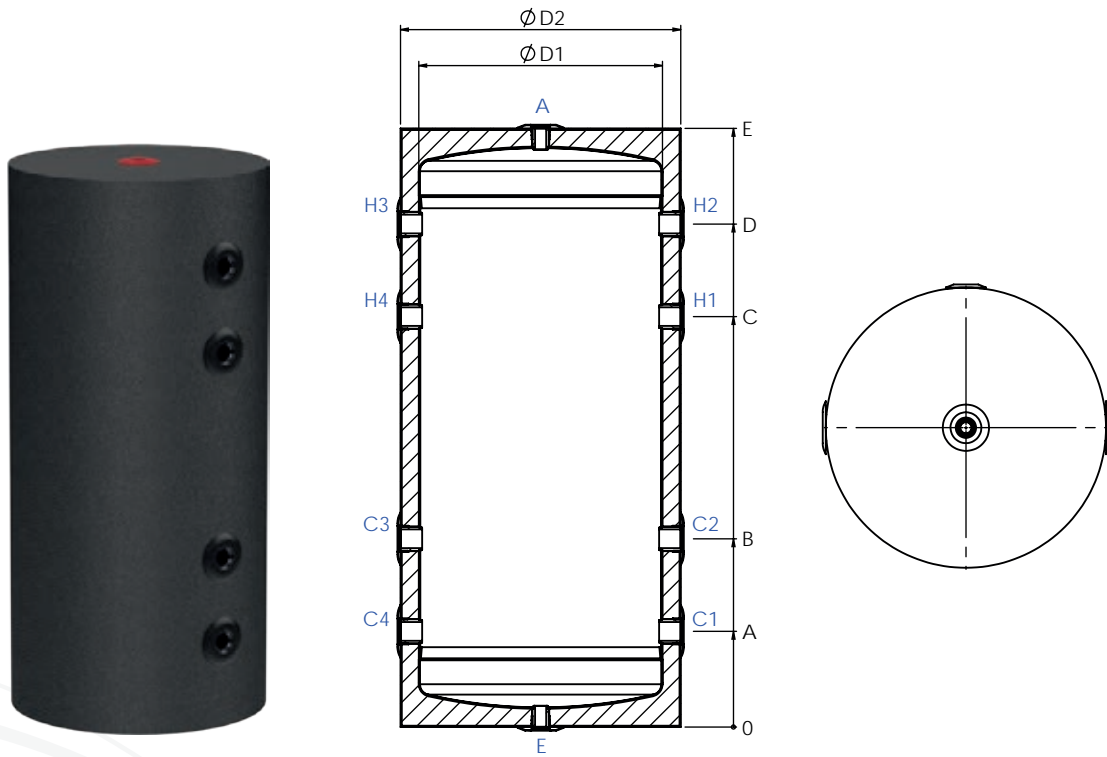

DIMENSIONS							
Varmbuffer	A	B	C	D	E	D1	D2
50	125	275	645	795	920	280	340
80	155	305	915	1065	1220	304	364
100	155	305	665	815	970	394	454

**SCHEMATIC DIAGRAM OF INSTALLATION**

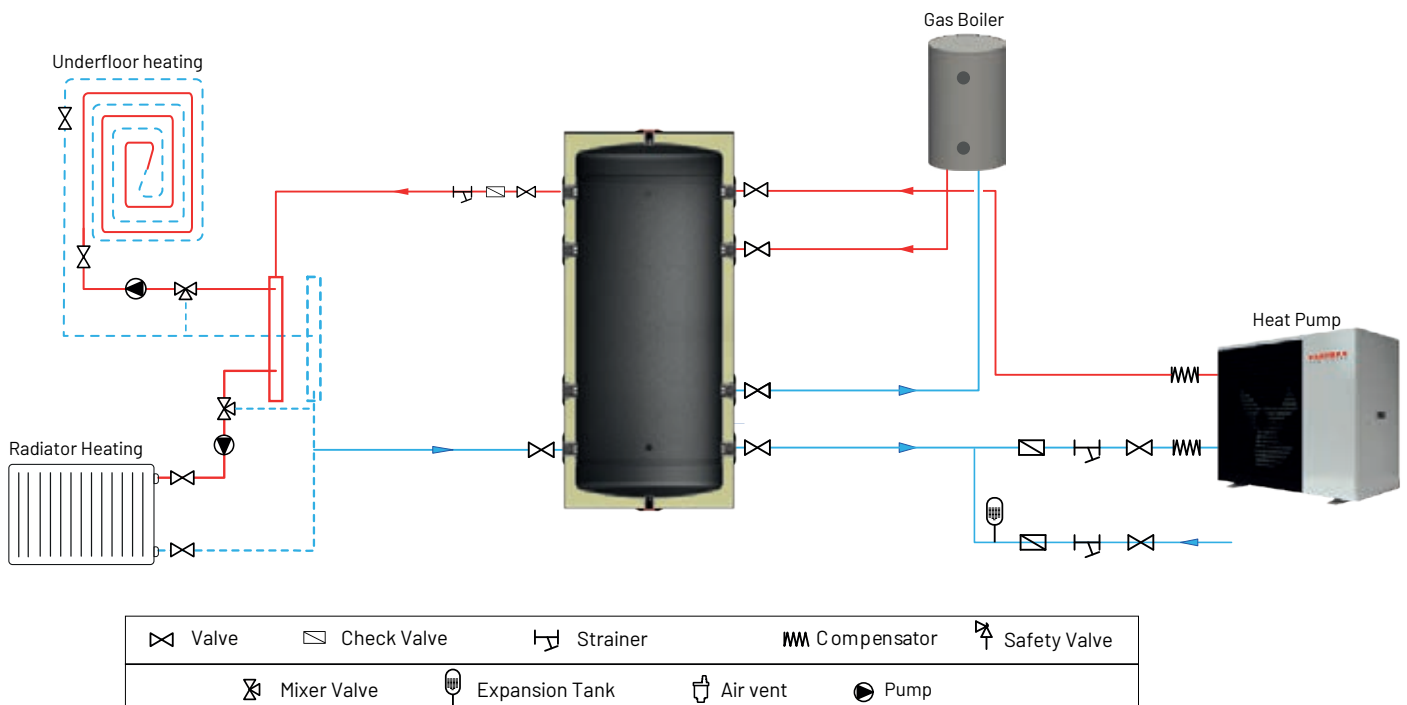

# SOLIBUFFER

BUFFER

## GENERAL INFORMATION

- ✓ When choosing a non-solar heat source, this is the most efficient model.
- ✓ Perfectly compatible with heat pumps.
- ✓ The buffer tank provides hydraulic separation between the heat pump circuit and the heating circuit flows. It also stores excess energy and ensures that hot water is available for sudden demands.
- ✓ Protects your heat pump from the negative effects of short cycling. Short cycling not only leads to higher operating costs, but can also damage your heat pump, reducing its lifespan and overall energy efficiency performance.
- ✓ Optional electric heater support.
- ✓ High-quality insulated polyurethane.
- ✓ No anode rod required.
- ✓ Minimal maintenance.
- ✓ Easy installation thanks to compact design



SOLIBUFFER		50	100	200	300	500	800	1000
<b>Product information</b>								
Energy efficiency class	-	C	C	C	C	D	E	E
Heat loss	W	54	62	74	85	140	195	220
Tank volume	L	50	100	170	245	460	850	1030
<b>Basic data</b>								
Weight	kg	20	40	55	73	90	140	160
Dimensions (height/diameter)	mm	570 X 450	750 X 540	1200 X 540	1750 X 540	1625 X 750	1850 X 1010	2150 X 1010
Max permissible boiler water temperature	°C	95	95	95	95	95	95	95
Maximum working pressure	bar	6	6	6	6	6	6	6
Insulating material	-	PU	PU	PU	PU	PU	Sponge	Sponge
Insulating thickness	mm	30	50	50	50	50	80	80
Outer cylinder material	-	Static painted galvanized sheet				Artificial leather		
<b>Pipe connection</b>								
Feed water in/out	inch	G 1"	G 1 1/4"	G 1 1/4"	G 1 1/4"	G 2"	G 2"	G 2"
Underfloor heating in/out	inch	G 1"	G 1 1/4"	G 1 1/4"	G 1 1/4"	G 2"	G 2"	G 2"
Electric heater	inch	-	G 1 1/4"	G 1 1/4"	G 1 1/4"	G 2"	G 2"	G 2"
Sensor	inch	-	G 1/2"	G 1/2"	G 1/2"	G 1/2"	G 1/2"	G 1/2"
Emptying	inch	G 1/2"	G 1/2"	G 1/2"	G 1/2"	G 1/2"	G 1/2"	G 1/2"

\*Solimpeks reserves the right to make changes to this table at any time.

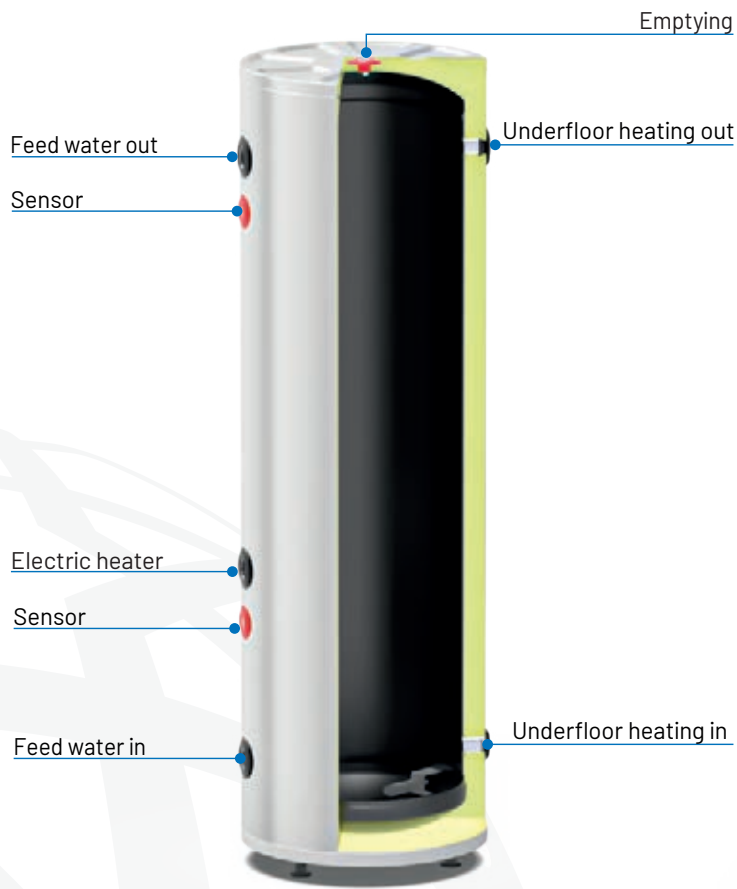

SCHEMATIC DIAGRAM OF INSTALLATION

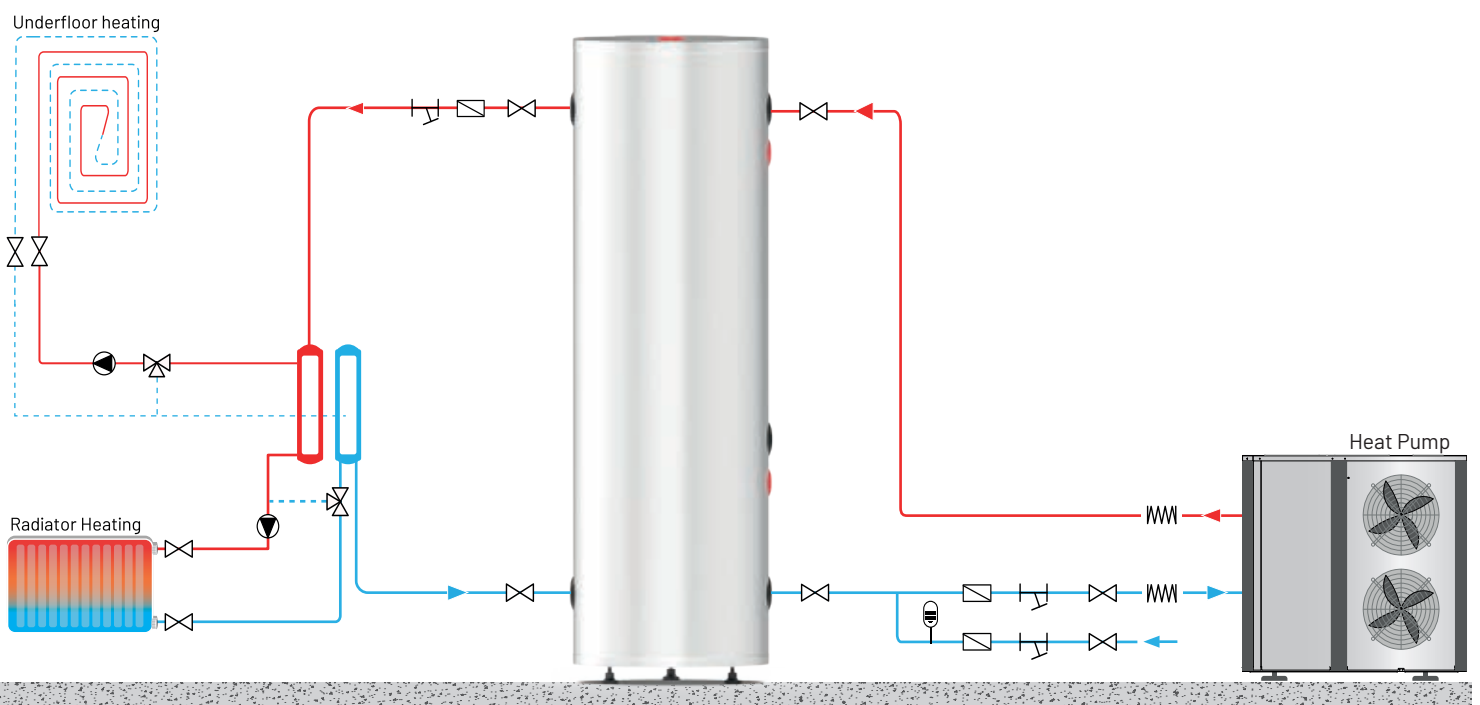

# SOLITANK

DHW TANK + BUFFER

# SOLITANK

## GENERAL INFORMATION

- ✓ Solitank models can store in 2 different versions at the same time according to the system needs. Domestic hot water + buffer tank.
- ✓ Hot water stored in the tank is used both for heating support and for heating domestic water.
- ✓ Domestic water is heated instantly in the spiral structure of the Chrome-Nickel 316L stainless steel in the tank. In this way, the formation of Legionella bacteria is prevented.
- ✓ Since Solitank models can be used as buffer tanks, they provide hydraulic separation between the heat pump circuit and the heating circuit flows. They also store excess energy and ensure that hot water is ready for sudden demands.
- ✓ Easy installation thanks to its compact design
- ✓ Perfectly compatible with heat pumps.
- ✓ Optional electric heater support.
- ✓ High quality insulated polyurethane.
- ✓ No anode rod required.
- ✓ Minimum maintenance.



SOLITANK		200	300	500	800	1000
<b>Product information</b>						
Energy efficiency class	-	C	C	D	E	E
Heat loss	W	74	85	140	195	220
Tank volume	L	170	245	460	850	1030
<b>Basic data</b>						
Weight	kg	67	85	106	165	190
Dimensions (height/diameter)	mm	1200 X 540	1750 X 540	1700 X 750	1850 X 1010	2150 X 1010
Max permissible boiler water temperature	°C	95	95	95	95	95
Maximum working pressure	bar	6	6	6	6	6
Insulating material	-	PU	PU	PU	Sponge	Sponge
Insulating thickness	mm	50	50	50	80	80
Outer cylinder material	-	Static painted galvanized sheet			Artificial leather	
<b>Domestic water exchanger (AISI 316L)</b>						
Water volume of the heat exchanger	L	12	12	13.5	22.5	27.5
Domestic water heat exchanger surface area	m <sup>2</sup>	3.8	3.8	4.3	7.2	8.7
Maximum working pressure	bar	6	6	6	6	6
<b>Pipe connection</b>						
Feed water in/out	inch	G 1 1/4"	G 1 1/4"	G 2"	G 2"	G 2"
Underfloor heating in/out	inch	G 1 1/4"	G 1 1/4"	G 2"	G 2"	G 2"
Electric heater	inch	G 1 1/4"	G 1 1/4"	G 2"	G 2"	G 2"
Domestic water in/out	inch	G 3/4"	G 3/4"	G 3/4"	G 3/4"	G 3/4"
Sensor	inch	G 1/2"	G 1/2"	G 1/2"	G 1/2"	G 1/2"
Emptying	inch	G 1/2"	G 1/2"	G 1/2"	G 1/2"	G 1/2"

\*Solimpeks reserves the right to make changes to this table at any time.

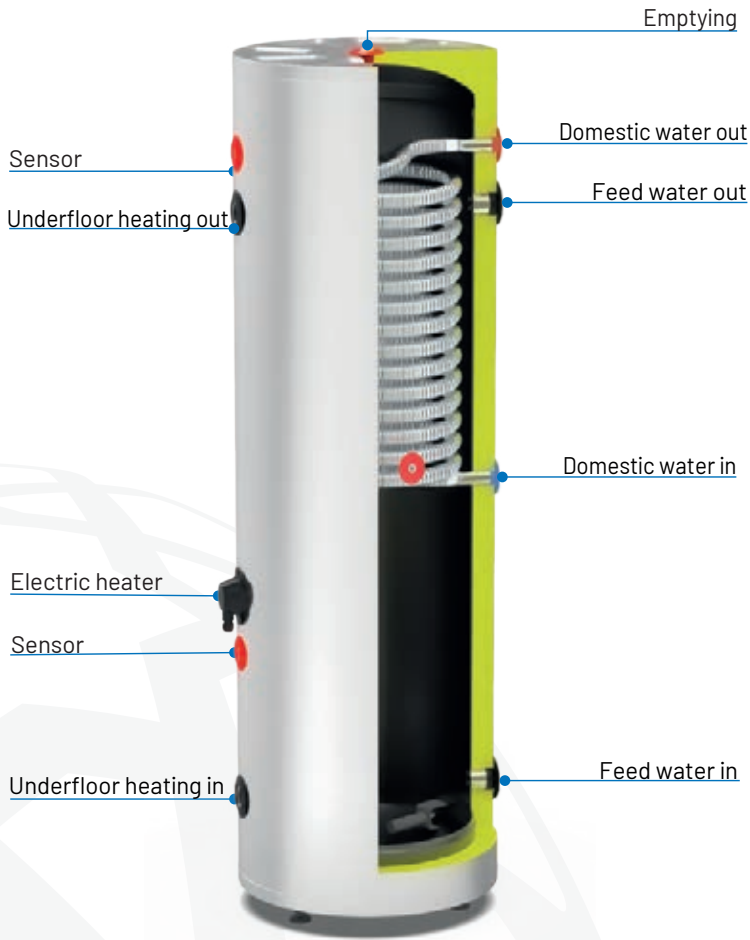

- ✓ More than 50% extra performance compared to traditional pipe
- ✓ Larger surface area, better heat transfer capacity and higher efficiency
- ✓ Stainless steel (AISI 316L) hose is suitable for drinking water application and highly resistant to corrosion.

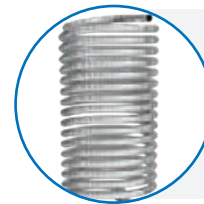

Single flexible pipe

**SCHEMATIC DIAGRAM OF INSTALLATION**

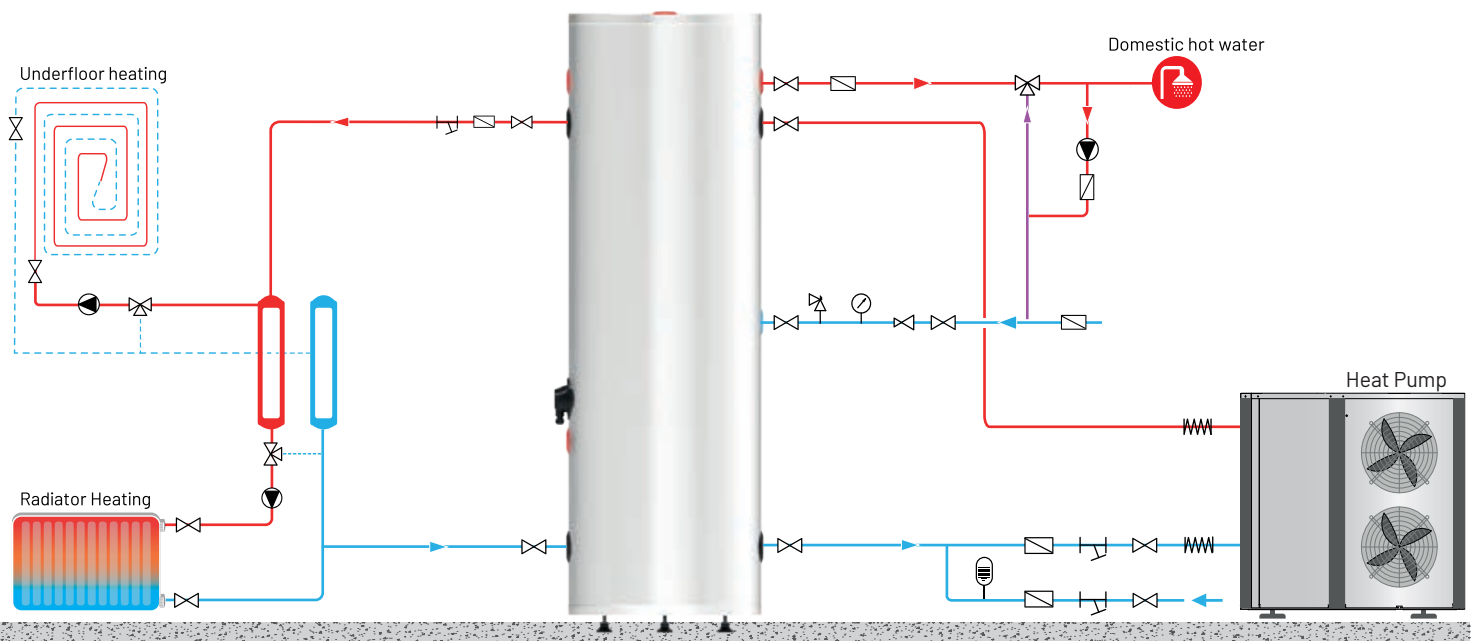

# SOLIKOMBI

DHW TANK + SOLAR TANK + BUFFER

## GENERAL INFORMATION

- ✓ Solikombi can store in 3 different versions at the same time according to the system needs. Solar energy + domestic hot water + buffer tank.
- ✓ The hot water stored in the tank is used both for heating support and for heating the domestic water.
- ✓ The domestic water is heated instantly within the spiral structure of the Chrome-Nickel 316L stainless steel in the tank. In this way, the formation of Legionella bacteria is prevented.
- ✓ Since it can be used as a buffer tank in Solikombi models, it provides hydraulic separation between the heat pump circuit and the heating circuit flows. It also stores excess energy and ensures that hot water is ready for sudden demands.
- ✓ Solikombi boilers can integrate more than one heat source.
- ✓ This is the most effective model when choosing a solar heat source.
- ✓ Perfectly compatible with heat pumps.
- ✓ Easy installation thanks to its compact design
- ✓ Optional electric heater support.
- ✓ High quality insulated polyurethane.
- ✓ No anode rod required.
- ✓ Minimum maintenance.



SOLIKOMBI		300	500	800	1000
<b>Product information</b>					
Energy efficiency class	-	C	D	E	E
Heat loss	W	85	140	195	220
Tank volume	L	245	460	850	1030
<b>Basic data</b>					
Weight	kg	89	112	175	190
Dimensions (height/diameter)	mm	1750 X 540	1700 X 750	1850 X 1010	2150 X 1010
Max permissible boiler water temperature	°C	95	95	95	95
Maximum working pressure	bar	6	6	6	6
Insulating material	-	PU	PU	Sponge	Sponge
Insulating thickness	mm	50	50	80	80
Outer cylinder material	-	Static painted galvanized sheet		Artificial leather	
<b>Domestic water exchanger (AISI 316L)</b>					
Water volume of the heat exchanger	L	12	13.5	22.5	27.5
Domestic water heat exchanger surface area	m <sup>2</sup>	3.8	4.3	7.2	8.7
Maximum working pressure	bar	6	6	6	6
<b>Solar heating support (AISI 316L)</b>					
Water volume of the heat exchanger	L	5.7	6.6	7.8	9.3
Domestic water heat exchanger surface area	m <sup>2</sup>	1.8	2.1	2.5	3
Maximum working pressure	bar	6	6	6	6
<b>Pipe connection</b>					
Feed water in/out	inch	G 1 1/4"	G 2"	G 2"	G 2"
Underfloor heating in/out	inch	G 1 1/4"	G 2"	G 2"	G 2"
Electric heater	inch	G 1 1/4"	G 2"	G 2"	G 2"
Domestic water in/out	inch	G 3/4"	G 3/4"	G 3/4"	G 3/4"
Solar input/output	inch	G 3/4"	G 3/4"	G 3/4"	G 3/4"
Sensor	inch	G 1/2"	G 1/2"	G 1/2"	G 1/2"
Emptying	inch	G 1/2"	G 1/2"	G 1/2"	G 1/2"

\*Solimpeks reserves the right to make changes to this table at any time.

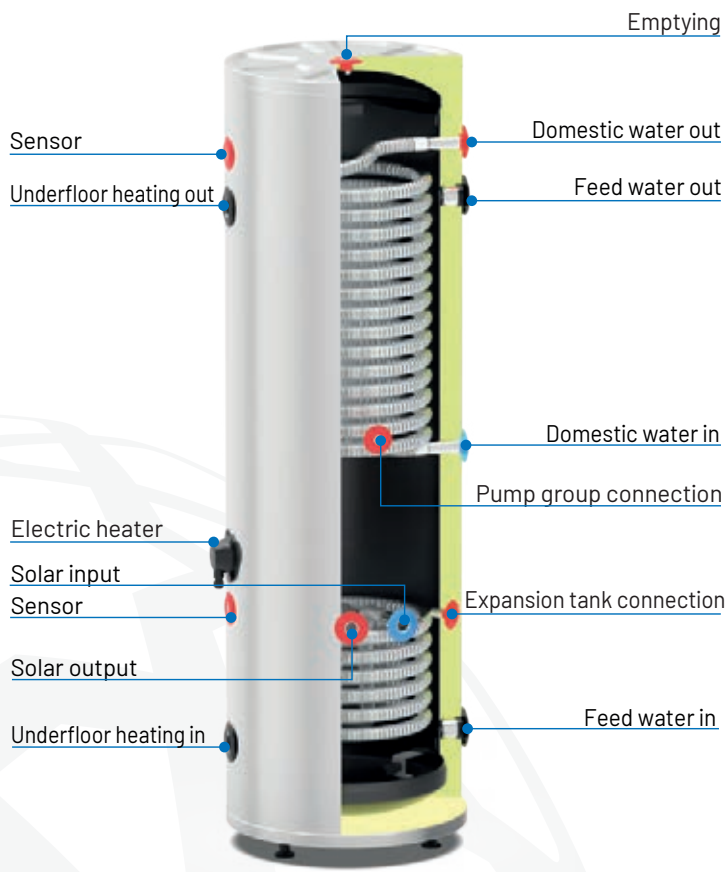

- ✓ More than 50% extra performance compared to traditional pipe
- ✓ Larger surface area, better heat transfer capacity and higher efficiency
- ✓ Stainless steel (AISI 316L) hose is suitable for drinking water application and highly resistant to corrosion.

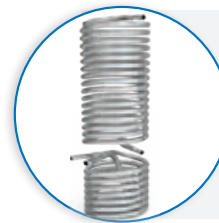

Double flexible pipe

**SCHEMATIC DIAGRAM OF INSTALLATION**

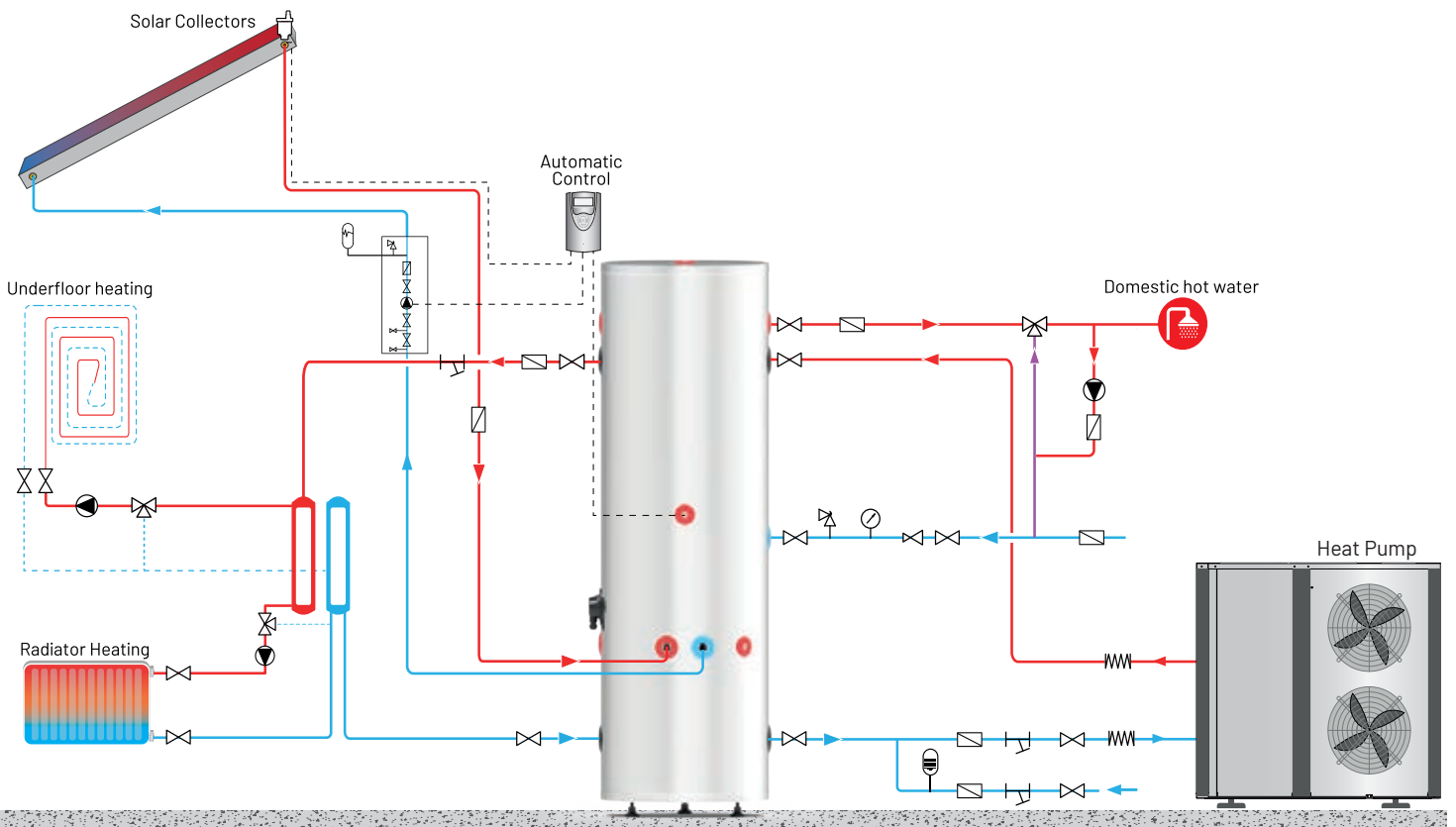

# ENAMEL TSE-VA

## GENERAL INFORMATION

- ✓ Enamel coating in accordance with DIN 4753/3 standard
- ✓ Production in accordance with TS EN 12897 Standard
- ✓ The inner surfaces of the boiler are advanced technology enamel
- ✓ 200-400 µm enamel thickness
- ✓ Polyurethane with high quality insulation.
- ✓ Easy installation thanks to its compact design
- ✓ Optional electric heater support.



Enamel TSE-VA		160	200	300	500
<b>Code</b>		MA-2312	MA-2298	MA-2301	MA-2313
Weight	kg	50	60	80	80
Dimensions (height/diameter)	mm	1050 X 580	1280 X 580	1780 X 580	1630 X 750
Max permissible boiler water temperature	°C	95	95	95	95
Maximum working pressure	bar	6	6	6	6
Insulating material	-	PU	PU	PU	PU
Insulating thickness	mm	50	50	50	50
Outer cylinder material	-	Static painted galvanized sheet			Artificial leather
<b>Pipe connection</b>					
Cleaning flange		Universal	Universal	Universal	Universal
Electric heater	inch	IG 1 1/4"	IG 1 1/4"	IG 1 1/4"	IG 1 1/4"
Domestic water in/out	inch	IG 3/4"	IG 3/4"	IG 3/4"	IG 3/4"
Recirculation	inch	IG 3/4"	IG 3/4"	IG 3/4"	IG 3/4"
Anode rod	inch	IG 1 1/4"	IG 1 1/4"	IG 1 1/4"	IG 1 1/4"
Sensor	inch	IG 1/2"	IG 1/2"	IG 1/2"	IG 1/2"
Blind connection	inch	IG 1 1/4"	IG 1 1/4"	IG 1 1/4"	IG 1 1/4"

\*Solimpeks reserves the right to make changes to this table at any time.

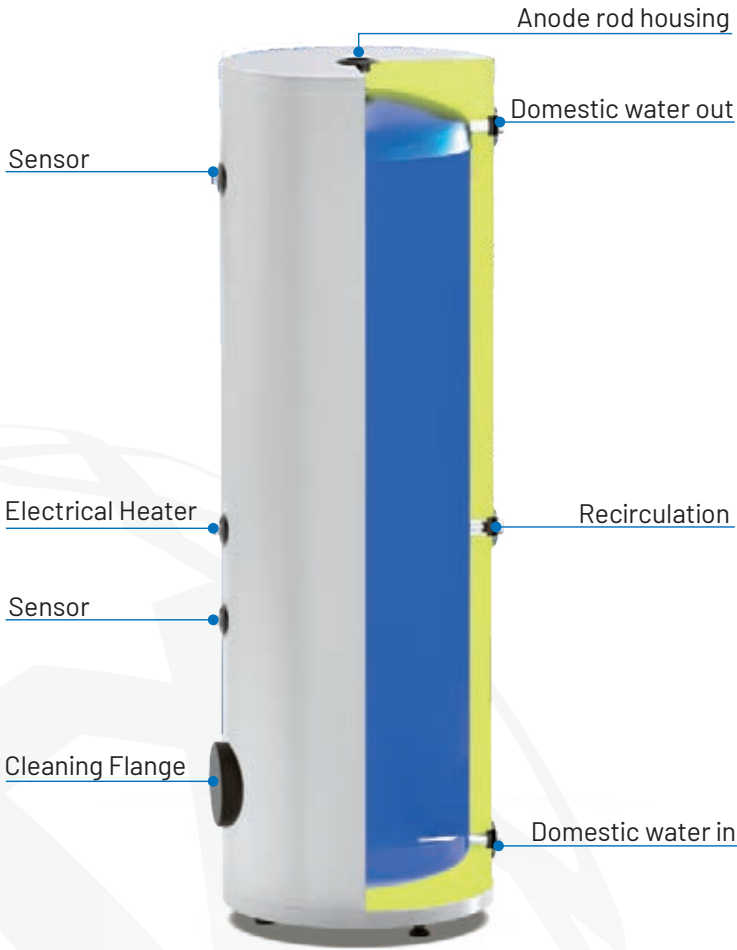

- ✓ Enamel coating according to DIN 4753-3 Standard
- ✓ 200-400 µm enamel thickness
- ✓ Long service life.

**SCHEMATIC DIAGRAM OF INSTALLATION**

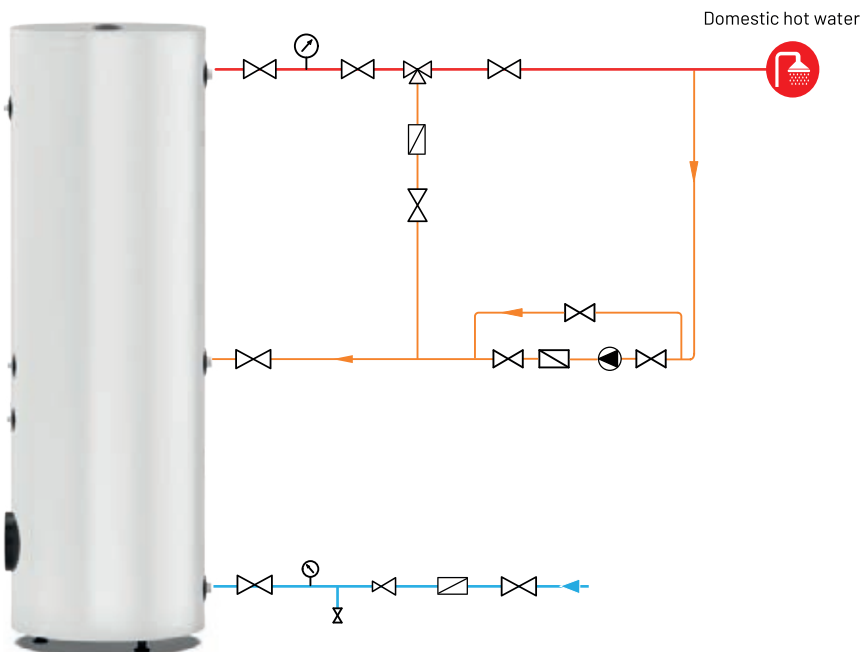

# ENAMEL TSE-VS

## GENERAL INFORMATION

- ✓ Enamel coating in accordance with DIN 4753/3 standard
- ✓ Production in accordance with TS EN 12897 Standard
- ✓ The inner surfaces of the boiler are advanced technology enamel
- ✓ 200-400 µm enamel thickness
- ✓ Perfectly compatible with solar systems.
- ✓ Polyurethane with high quality insulation.
- ✓ Easy installation thanks to its compact design
- ✓ Optional electric heater support.



Enamel TSE-VS		160	200	300	500
<b>Code</b>		MA-2314	MA-2297	MA-2302	MA-2315
Weight	kg	65	75	104	108
Dimensions(height/diameter)	mm	1050 X 580	1280 X 580	1780 X 580	1630 X 750
Max permissible boiler water temperature	°C	95	95	95	95
Maximum working pressure	bar	6	6	6	6
Insulating material	-	PU	PU	PU	PU
Insulating thickness	mm	50	50	50	50
Outer cylinder material	-	Static painted galvanized sheet			Artificial leather
<b>Heat source exchanger</b>					
Water volume of the heat exchanger	L	7	8	11	16
Surface area	m <sup>2</sup>	0.75	1	1.3	2
Maximum working pressure	bar	6	6	6	6
<b>Pipe connection</b>					
Feed water in/out	inch	IG 1"	IG 1"	IG 1"	IG 1"
Cleaning flange		Universal	Universal	Universal	Universal
Electric heater	inch	IG 1 1/4"	IG 1 1/4"	IG 1 1/4"	IG 1 1/4"
Domestic water in/out	inch	IG 3/4"	IG 3/4"	IG 3/4"	IG 3/4"
Recirculation	inch	IG 3/4"	IG 3/4"	IG 3/4"	IG 3/4"
Anode rod	inch	IG 1 1/4"	IG 1 1/4"	IG 1 1/4"	IG 1 1/4"
Sensor	inch	IG 1/2"	IG 1/2"	IG 1/2"	IG 1/2"
Blind connection	inch	IG 1 1/4"	IG 1 1/4"	IG 1 1/4"	IG 1 1/4"

\*Solimpeks reserves the right to make changes to this table at any time.

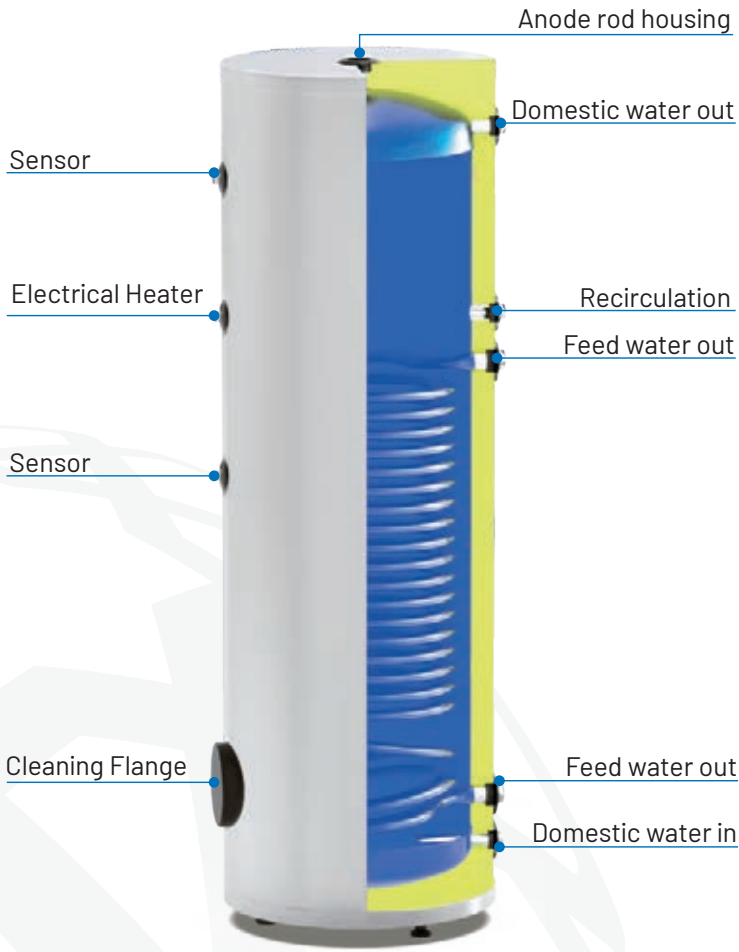

- ✓ Enamel coating according to DIN 4753-3 Standard
- ✓ 200-400 µm enamel thickness
- ✓ Long service life.

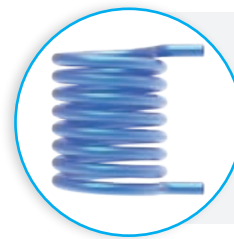

Single serpentine

**SCHEMATIC DIAGRAM OF INSTALLATION**

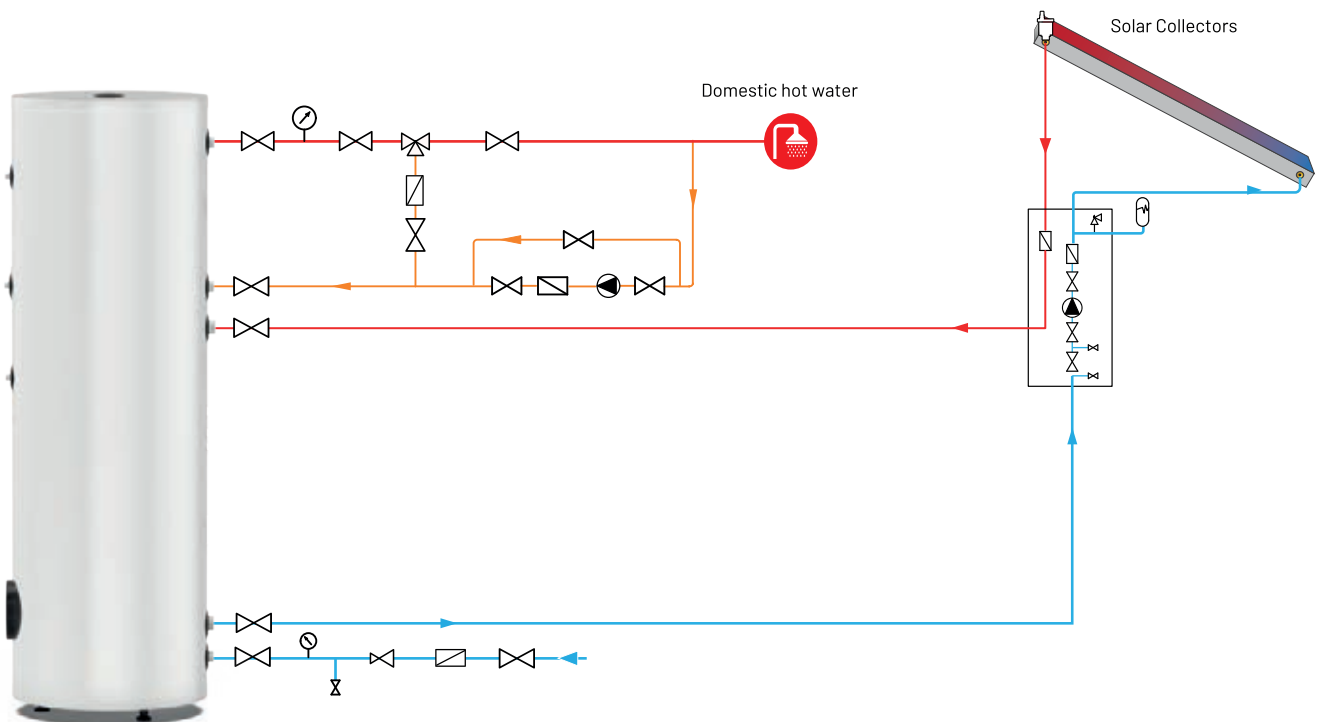

# ENAMEL TSE-VS HP

## GENERAL INFORMATION

- ✓ Enamel coating in accordance with DIN 4753/3 standard
- ✓ Production in accordance with TS EN 12897 Standard
- ✓ The inner surfaces of the boiler are advanced technology enamel
- ✓ 200-400 µm enamel thickness
- ✓ Perfectly compatible with heat pumps.
- ✓ Polyurethane with high quality insulation.
- ✓ Easy installation thanks to its compact design
- ✓ Optional electric heater support.



Enamel TSE-VS HP		160	200	300	500
<b>Code</b>		MA-2308	MA-2286	MA-2299	MA-2309
Weight	kg	79	100	140	160
Dimensions (height/diameter)	mm	1050 X 580	1280 X 580	1780 X 580	1630 X 750
Max permissible boiler water temperature	°C	95	95	95	95
Maximum working pressure	bar	6	6	6	6
Insulating material	-	PU	PU	PU	PU
Insulating thickness	mm	50	50	50	50
Outer cylinder material	-	Static painted galvanized sheet			Artificial leather
<b>Heat source exchanger</b>					
Water volume of the heat exchanger	L	11	18	26	33
Surface area	m <sup>2</sup>	1.3	2.1	3.1	4
Maximum working pressure	bar	6	6	6	6
<b>Pipe connection</b>					
Feed water in/out	inch	IG 1"	IG 1"	IG 1"	IG 1"
Cleaning flange		Universal	Universal	Universal	Universal
Electric heater	inch	IG 1 1/4"	IG 1 1/4"	IG 1 1/4"	IG 1 1/4"
Domestic water in/out	inch	IG 3/4"	IG 3/4"	IG 3/4"	IG 3/4"
Recirculation	inch	IG 3/4"	IG 3/4"	IG 3/4"	IG 3/4"
Anode rod	inch	IG 1 1/4"	IG 1 1/4"	IG 1 1/4"	IG 1 1/4"
Sensor	inch	IG 1/2"	IG 1/2"	IG 1/2"	IG 1/2"
Blind connection	inch	IG 1 1/4"	IG 1 1/4"	IG 1 1/4"	IG 1 1/4"

\*Solimpeks reserves the right to make changes to this table at any time.

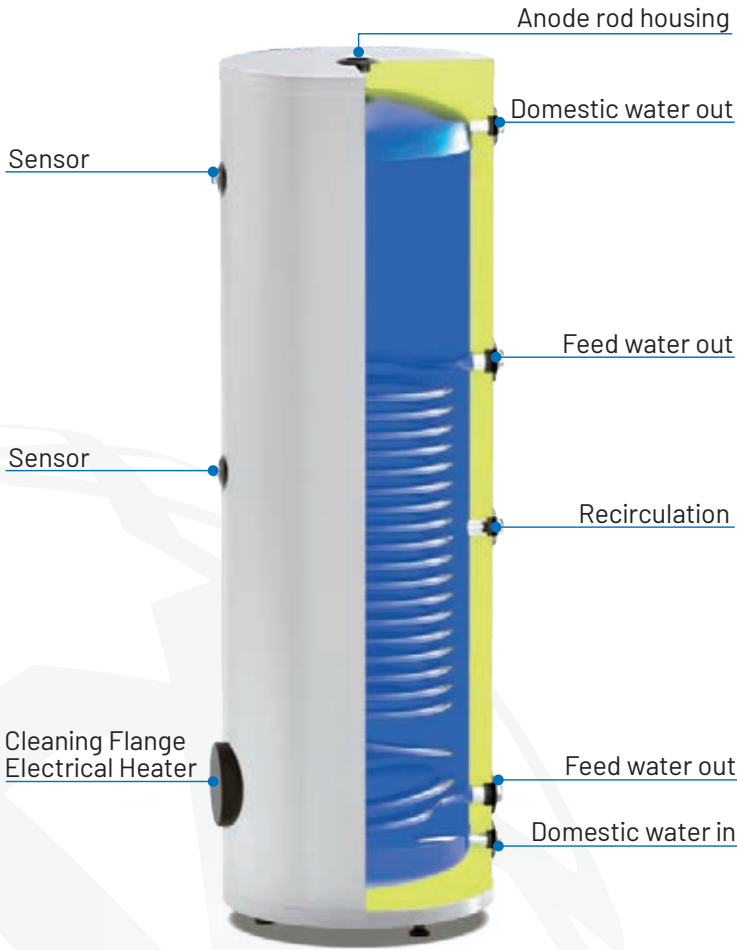

- ✓ Enamel coating according to DIN 4753-3 Standard
- ✓ 200-400 µm enamel thickness
- ✓ Long service life.

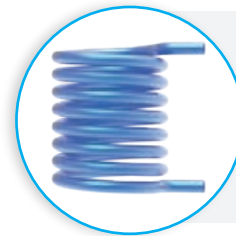

Single serpentine

**SCHEMATIC DIAGRAM OF INSTALLATION**

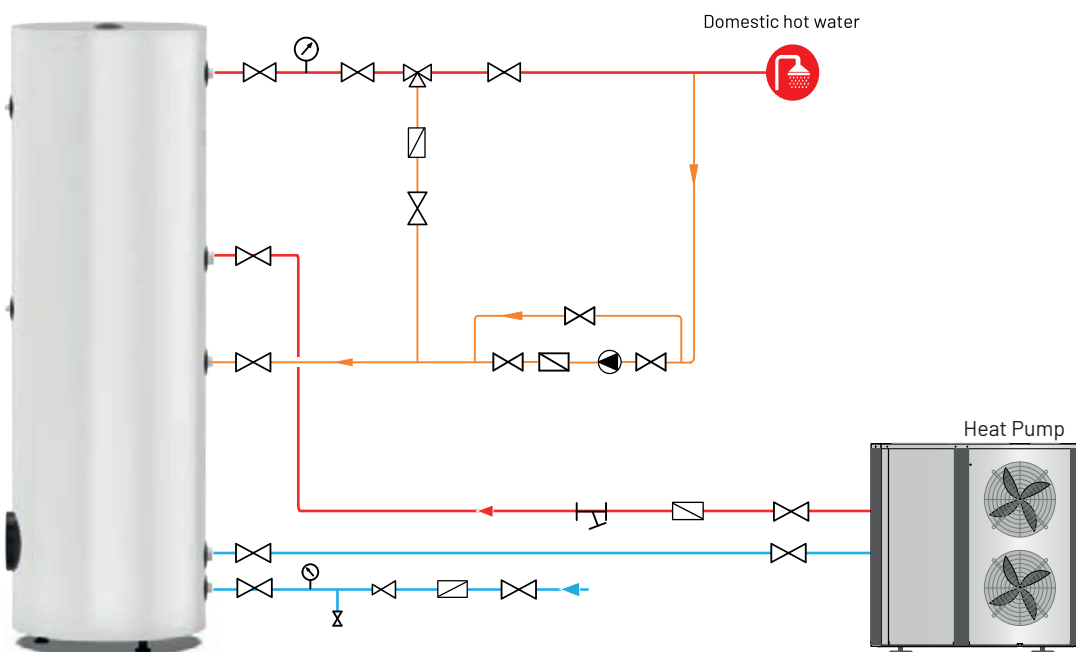

# TSEVD

## ENAMEL TSE-VD

### GENERAL INFORMATION

- ✓ Enamel coating in accordance with DIN 4753/3 standard
- ✓ Production in accordance with TS EN 12897 Standard
- ✓ Boiler interior surfaces are high-tech enamel
- ✓ 200-400 µm enamel thickness
- ✓ Perfectly compatible with solar energy.
- ✓ Perfectly compatible with heat pumps.
- ✓ High quality insulated polyurethane.
- ✓ Easy installation thanks to its compact design
- ✓ Optional electric heater support.



Enamel TSE-VD		160	200	300	500
<b>Code</b>		MA-2310	MA-2296	MA-2300	MA-2311
Weight	kg	70	92	125	140
Dimensions (height/diameter)	mm	1050 X 580	1280 X 580	1780 X 580	1630 X 750
Max permissible boiler water temperature	°C	95	95	95	95
Maximum working pressure	bar	6	6	6	6
Insulating material	-	PU	PU	PU	PU
Insulating thickness	mm	50	50	50	50
Outer cylinder material	-	Static painted galvanized sheet			Artificial leather
<b>1.Heat source exchanger</b>					
Water volume of the heat exchanger	L	3	7	8	11
Surface area	m <sup>2</sup>	0.4	0.75	1	1.3
Maximum working pressure	bar	6	6	6	6
<b>2.Heat source exchanger</b>					
Water volume of the heat exchanger	L	7	8	11	16
Surface area	m <sup>2</sup>	0.75	1	1.3	2
Maximum working pressure	bar	6	6	6	6
<b>Pipe connection</b>					
Feed water in/out	inch	IG 1"	IG 1"	IG 1"	IG 1"
Cleaning flange		Universal	Universal	Universal	Universal
Electric heater	inch	IG 1 1/4"	IG 1 1/4"	IG 1 1/4"	IG 1 1/4"
Domestic water in/out	inch	IG 3/4"	IG 3/4"	IG 3/4"	IG 3/4"
Solar input/output	inch	IG 1"	IG 1"	IG 1"	IG 1"
Recirculation	inch	IG 3/4"	IG 3/4"	IG 3/4"	IG 3/4"
Anode rod	inch	IG 1 1/4"	IG 1 1/4"	IG 1 1/4"	IG 1 1/4"
Sensor	inch	IG 1/2"	IG 1/2"	IG 1/2"	IG 1/2"
Blind connection	inch	IG 1 1/4"	IG 1 1/4"	IG 1 1/4"	IG 1 1/4"

\*Solimpeks reserves the right to make changes to this table at any time.

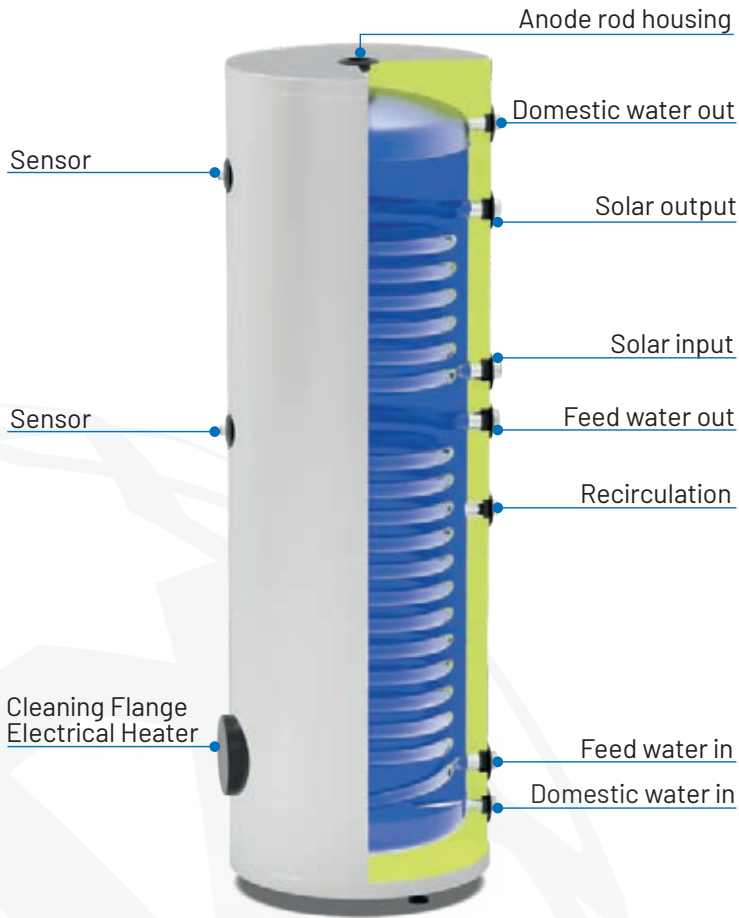

- ✓ Enamel coating according to DIN 4753-3 Standard
- ✓ 200-400 µm enamel thickness
- ✓ Long service life.

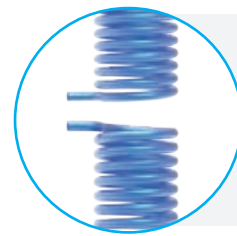

Double serpentine

SCHEMATIC DIAGRAM OF INSTALLATION

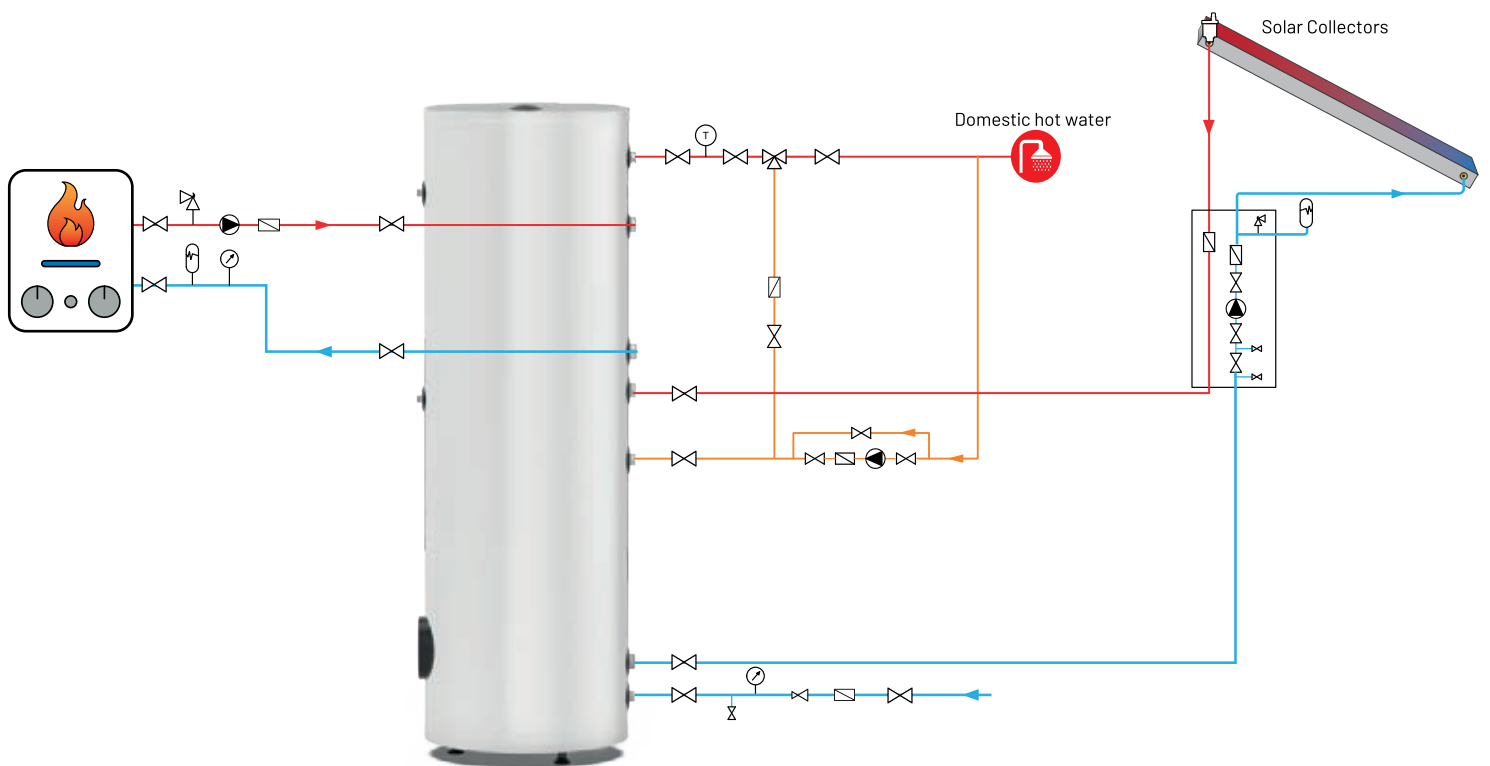

# TSM

- ✓ Solar Keymark certified
- ✓ No magnesium anode required and maintenance free
- ✓ Unpressurized tank, pressurized water
- ✓ 5 years warranty

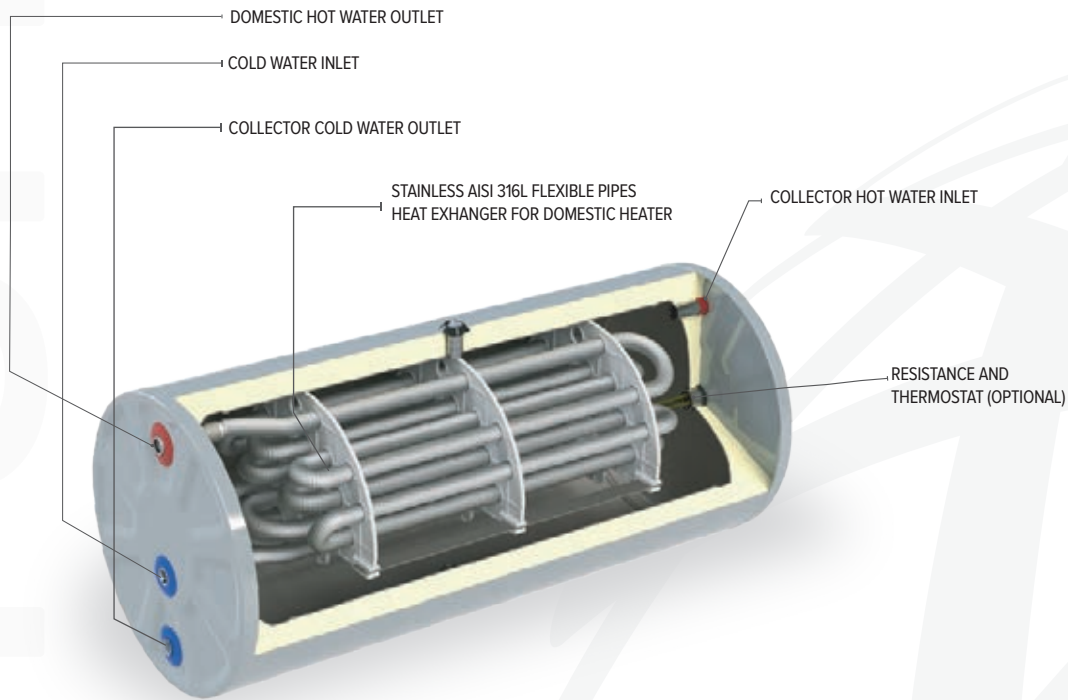

TSM		120	150	200	300	350
<b>Product information</b>						
Capacity	(L/day)	120	135	170	245	305
<b>Basic data</b>						
Weight	kg	48	52	60	80	100
Dimensions (height/diameter)	mm	950 X 540	1030 X 540	1200 X 540	1725 X 540	2165 X 540
Max permissible boiler water temperature	°C	95	95	95	95	95
Maximum working pressure	bar	6	6	6	6	6
Insulating material	-	PU	PU	PU	PU	PU
Insulating thickness	mm	50	50	50	50	50
Outer cylinder material	-	Static painted galvanized sheet				
<b>Domestic water exchanger (AISI 316L)</b>						
Water volume of the heat exchanger	L	12	12	12	12	12.6
Domestic water heat exchanger surface area	m <sup>2</sup>	3.8	3.8	3.8	3.8	4
Maximum working pressure	bar	6	6	6	6	6
<b>Pipe connection</b>						
Solar in/out	inch	G 3/4"	G 3/4"	G 3/4"	G 3/4"	G 3/4"
Expansion tank connection	inch	G 3/4"	G 3/4"	G 3/4"	G 3/4"	G 3/4"
Domestic water in/out	inch	G 3/4"	G 3/4"	G 3/4"	G 3/4"	G 3/4"
Tank filling connection	inch	G 3/4"	G 3/4"	G 3/4"	G 3/4"	G 3/4"
Electric heater	inch	G 1 1/4"	G 1 1/4"	G 1 1/4"	G 1 1/4"	G 1 1/4"

\*Solimpeks reserves the right to make changes to this table at any time.

# TSE

- 5 years warranty ✓
- Solar Keymark certified ✓
- Double Jacket Heat Exchanger ✓
- High Tech Industrial Enameling ✓
- Longlife Sacrificial Anode ✓

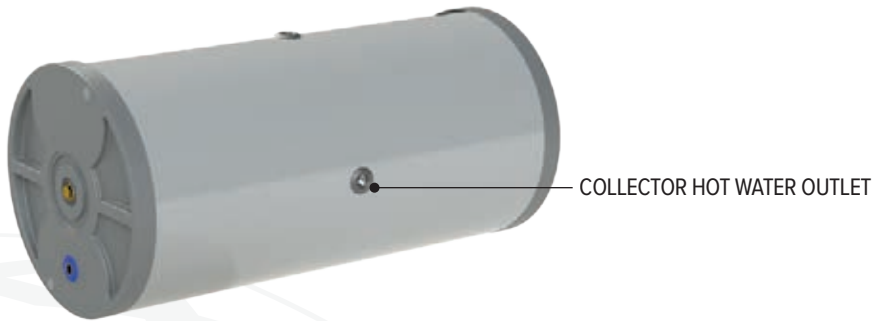

TSE		120	150	200	300
<b>Product information</b>					
Capacity	(L/day)	120	150	200	300
<b>Basic data</b>					
Weight	kg	53	57	70	101
Dimensions (height/diameter)	mm	1275 X 500	1000 X 600	1200 X 600	1800 X 600
Max permissible boiler water temperature	°C	95	95	95	95
Maximum working pressure	bar	6	6	6	6
Insulating material	-	PU	PU	PU	PU
Insulating thickness	mm	50	50	50	50
Outer cylinder material	-	Static painted galvanized sheet			
<b>Pipe connection</b>					
Solar in/out	inch	G 3/4"	G 3/4"	G 3/4"	G 3/4"
Expansion tank connection	inch	G 3/4"	G 3/4"	G 3/4"	G 3/4"
Domestic water in/out	inch	G 3/4"	G 3/4"	G 3/4"	G 3/4"
Safety valve	inch	G 3/4"	G 3/4"	G 3/4"	G 3/4"
Anode rod	inch	1"	1"	1"	1"
Electric heater	inch	G 1 1/4"	G 1 1/4"	G 1 1/4"	G 1 1/4"
Cleaning flange	inch	3"	3"	3"	3"

\*Solimpeks reserves the right to make changes to this table at any time.

# THERMOSIPHON SYSTEMS TSM

- ✓ Solar Keymark certified
- ✓ No need for a magnesium anode and maintenance free
- ✓ Unpressurized tank, pressurized water
- ✓ 5 years warranty

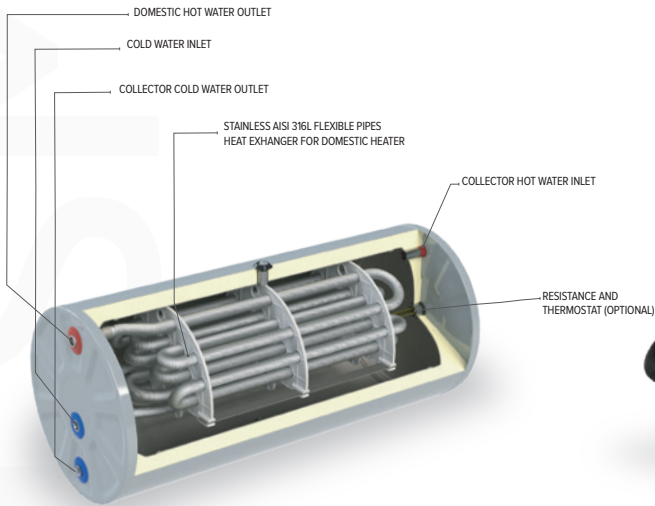

THERMOSIPHON SYSTEMS TSM		TSM 120	TSM 150	TSM 200	TSM 300
Solar fraction	%	84	80	81	82
Capacity	(L/day)	120	135	170	245
<b>Basic data</b>					
Weight	kg	48	52	60	80
Dimensions (height/diameter)	mm	950 X 540	1030 X 540	1200 X 540	1725 X 540
Max permissible boiler water temperature	°C	95	95	95	95
Maximum working pressure	bar	6	6	6	6
Insulating material	-	PU	PU	PU	PU
Insulating thickness	mm	50	50	50	50
Outer cylinder material	-	Static painted galvanized sheet			
<b>Domestic water exchanger (AISI 316L)</b>					
Water volume of the heat exchanger	L	12	12	12	12
Domestic water heat exchanger surface area	m <sup>2</sup>	3.8	3.8	3.8	3.8
Maximum working pressure	bar	6	6	6	6
<b>Collector</b>		<b>Wunder ALS 1809</b>	<b>Wunder ALS 2110</b>	<b>Wunder ALS 2512</b>	<b>Wunder ALS 2110 (2 pcs)</b>
Dimensions	mm	1927 X 927 X 90	1988 X 1041 X 90	1988 X 1218 X 90	1988 X 1041 X 90
Gross area	m <sup>2</sup>	1.79	2.07	2.42	2.07
Absorber area	m <sup>2</sup>	1.65	1.93	2.27	1.93
Weight empty	kg	24	28	32	28
Plate material	-	Highly selective aluminum			
Absorptance	%	95	95	95	95
Emittance	%	3	3	3	3
Glass material	-	Low iron tempered glass			
Insulation material	-	Rock wool	Rock wool	Rock wool	Rock wool

\*Solimpeks reserves the right to make changes to this table at any time.

# THERMOSIPHON SYSTEMS TSE

5 years warranty ✓

Solar Keymark certified ✓

Double Jacket Heat Exchanger ✓

High Tech Industrial Enameling ✓

Longlife Sacrificial Anode ✓

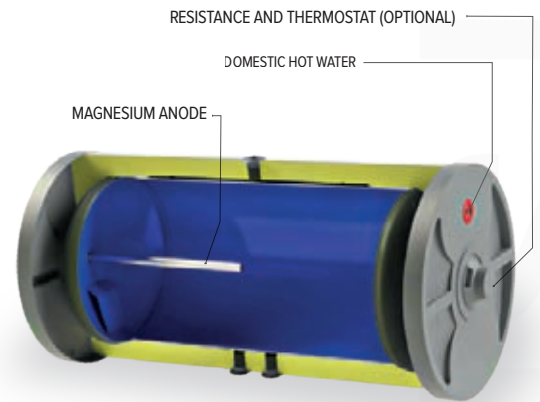

THERMOSIPHON SYSTEMS TSE		TSE 120	TSE 150	TSE 200	TSE 300
Solar fraction	%	84	80	77	82
Capacity	(L/day)	120	150	200	300
<b>Basic data</b>					
Weight	kg	53	57	70	101
Dimensions (height/diameter)	mm	1275 X 500	1000 X 600	1200 X 600	1800 X 600
Max permissible boiler water temperature	°C	95	95	95	95
Maximum working pressure	bar	6	6	6	6
Insulating material	-	PU	PU	PU	PU
Insulating thickness	mm	50	50	50	50
Outer cylinder material	-	Static painted galvanized sheet			
<b>Collector</b>		<b>Wunder ALS 1809</b>	<b>Wunder ALS 2110</b>	<b>Wunder ALS 2512</b>	<b>Wunder ALS 2110 (2 pcs)</b>
Dimensions	mm	1927 X 927 X 90	1988 X 1041 X 90	1988 X 1218 X 90	1988 X 1041 X 90
Gross area	m <sup>2</sup>	1.79	2.07	2.42	2.07
Absorber area	m <sup>2</sup>	1.65	1.93	2.27	1.93
Weight empty	kg	24	28	32	28
Plate material	-	Highly selective aluminum			
Absorptance	%	95	95	95	95
Emittance	%	3	3	3	3
Glass material	-	Low iron tempered glass			
Insulation material	-	Rock wool	Rock wool	Rock wool	Rock wool

\*Solimpeks reserves the right to make changes to this table at any time.

# WUNDER ALS

- ✓ Solar Keymark certified
- ✓ Selective aluminum
- ✓ Rock wool insulation
- ✓ Copper pipe
- ✓ Low iron tempered glass
- ✓ Laser welding
- ✓ 10 years warranty

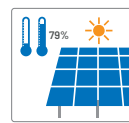
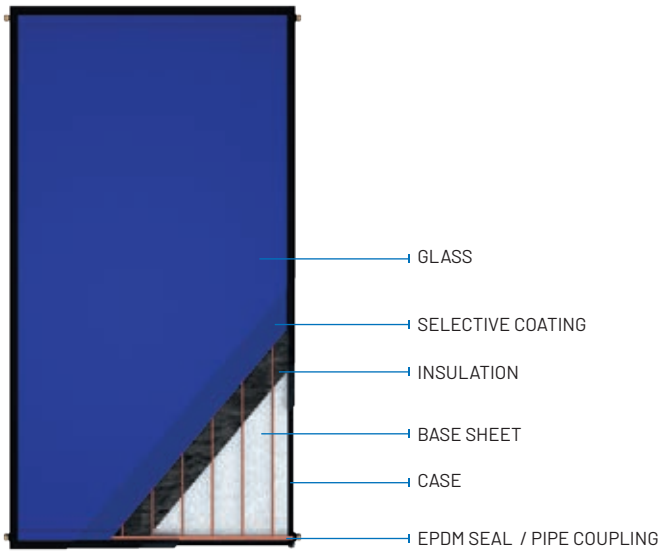

Thermal Efficiency

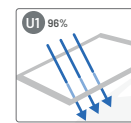

Radiation Transmittance

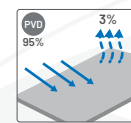

Absorption Rate

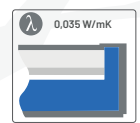

Insulation



Wunder ALS			Wunder ALS 1809	Wunder ALS 2110	Wunder ALS 2412	Wunder ALS 2512	Wunder ALS 2710	Wunder ALS 3010
TECHNICAL DATA	Thermal efficiency (Ag)	%	73	73	73	73	73	73
	Thermal efficiency (Aa)	%	79	79	79	79	79	79
	Dimensions	mm	1927 X 927 X 90	1988 X 1041 X 90	1988 X 1210 X 90	1988 X 1218 X 90	2220 X 1218 X 90	2427 X 1218 X 90
	Gross area	m <sup>2</sup>	1.79	2.07	2.4	2.42	2.7	2.97
	Absorber area	m <sup>2</sup>	1.65	1.93	2.24	2.27	2.54	2.79
	Weight empty	kg	24	28	32	32	36	39
	Absorber volume	L	1	1.15	1.45	1.45	1.56	1.6
	Max working pressure	bar	10	10	10	10	10	10
	Max operating temperature	°C	130	130	130	130	130	130
	Flow rate	kg/hm <sup>2</sup>	72	72	72	72	72	72
ABSORBER SURFACE	Plate Material		Highly Selective Aluminum					
	Absorptance	%	95	95	95	95	95	95
	Emittance	%	3	3	3	3	3	3
COPPER PIPE	Ø manifold pipe	mm	18	18	18	18	18	18
	Ø absorber pipe	mm	8	8	8	8	8	8
	Connection	inch	3/4"	3/4"	3/4"	3/4"	3/4"	3/4"
	Number of pipe		9	10	12	12	12	12
GLASS	Glass material		Low Iron Tempered Glass					
	Glass thickness	mm	3.2	3.2	3.2	3.2	3.2	3.2
INSULATION	Material		Rock Wool	Rock Wool	Rock Wool	Rock Wool	Rock Wool	Rock Wool
	Thickness	mm	40	40	40	40	40	40
	Density	kg/m <sup>3</sup>	50	50	50	50	50	50

# WUNDER ANSG



- Solar Keymark certified ✓
- Selective aluminum ✓
- Rock wool insulation ✓
- Copper pipe ✓
- Normal iron tempered glass ✓
- Laser welding ✓
- 10 years warranty ✓

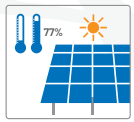

Thermal Efficiency

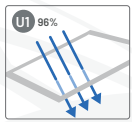

Radiation Transmittance

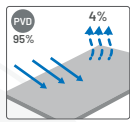

Absorption Rate

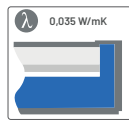

Insulation

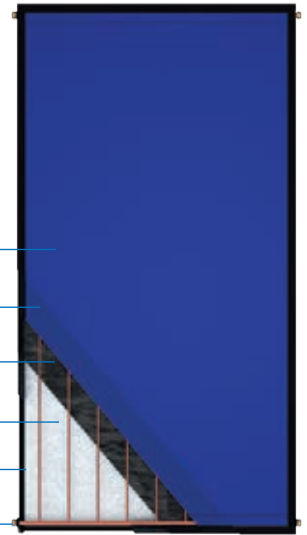

- GLASS
- SELECTIVE COATING
- INSULATION
- BASE SHEET
- CASE
- EPDM SEAL / PIPE COUPLING

## Wunder ANSG

## Wunder ANSG 1808

## Wunder ANSG 2108

## Wunder ANSG 2510

TECHNICAL DATA	Thermal efficiency (Ag)	%	70	70	70
	Thermal efficiency (Aa)	%	77	77	77
	Dimensions	mm	1927 X 927 X 90	1988 X 1041 X 90	1988 X 1218 X 90
	Gross area	m <sup>2</sup>	1.79	2.07	2.42
	Absorber area	m <sup>2</sup>	1.65	1.93	2.27
	Weight empty	kg	24	27	32
	Absorber volume	L	1	1.15	1.3
	Max working pressure	bar	10	10	10
	Max operating temperature	°C	130	130	130
	Flow rate	kg/hm <sup>2</sup>	72	72	72
ABSORBER SURFACE	Plate Material		Selective coating aluminum		
	Absorptance	%	95	95	95
	Emittance	%	4	4	4
COPPER PIPE	Ø manifold pipe	mm	18	18	18
	Ø absorber pipe	mm	8	8	8
	Connection	inch	3/4"	3/4"	3/4"
	Number of pipe		8	9	10
GLASS	Glass material		Normal Iron Tempered Glass		
	Glass thickness	mm	3.2	3.2	3.2
INSULATION	Material		Glass Wool	Glass Wool	Glass Wool
	Thickness	mm	50	50	50
	Density	kg/m <sup>3</sup>	50	50	50

# WUNDER ANP

- ✓ Solar Keymark certified
- ✓ Painted aluminum
- ✓ Rock wool insulation
- ✓ Copper pipe
- ✓ Normal iron tempered glass
- ✓ Laser welding
- ✓ 10 years warranty

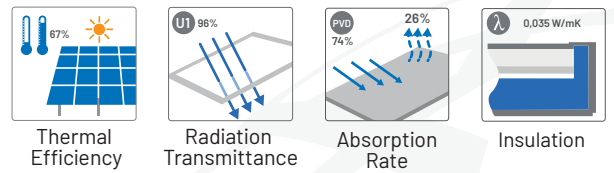
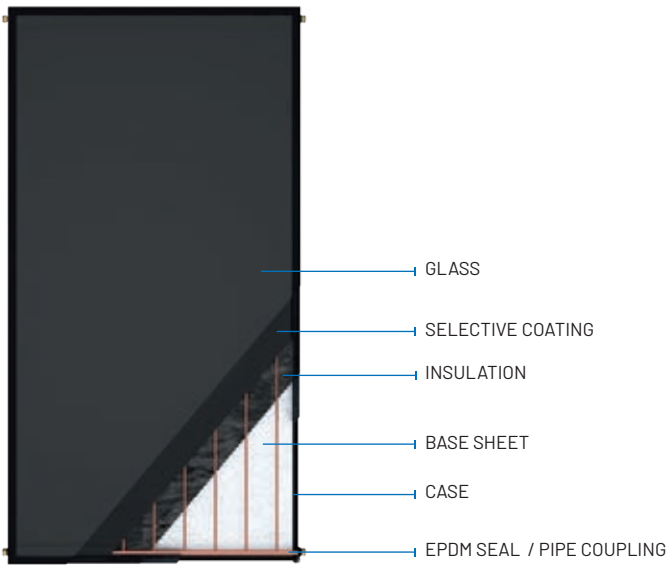

## Wunder ANP

## Wunder ANP 1808

## Wunder ANP 2108

## Wunder ANP 2510

Wunder ANP			Wunder ANP 1808	Wunder ANP 2108	Wunder ANP 2510
TECHNICAL DATA	Thermal efficiency(Ag)	%	64	64	64
	Thermal efficiency(Aa)	%	67	67	67
	Dimensions	mm	1927 X 927 X 90	1988 X 1041 X 90	1988 X 1218 X 90
	Gross area	m <sup>2</sup>	1.79	2.07	2.42
	Absorber area	m <sup>2</sup>	1.65	1.93	2.27
	Weight empty	kg	24	27	32
	Absorber volume	L	1	1.15	1.3
	Max working pressure	bar	10	10	10
	Max operating temperature	°C	130	130	130
	Flow rate	kg/hm <sup>2</sup>	72	73	74
ABSORBER SURFACE	Plate Material		Black aluminum		
	Absorptance	%	74	74	74
	Emittance	%	26	26	26
COPPER PIPE	Ø manifold pipe	mm	18	18	18
	Ø absorber pipe	mm	8	8	8
	Connection	inch	3/4"	3/4"	3/4"
	Number of pipe		8	9	10
GLASS	Glass material		Normal Iron Tempered Glass		
	Glass thickness	mm	3.2	3.2	3.2
INSULATION	Material		Glass Wool	Glass Wool	Glass Wool
	Thickness	mm	50	50	50
	Density	kg/m <sup>3</sup>	50	50	50

# WUNDER ALS DRAIN



- Solar Keymark certified ✓
- Selective aluminum ✓
- Rock wool insulation ✓
- Copper pipe ✓
- Low iron tempered glass ✓
- Laser welding ✓
- 10 years warranty ✓

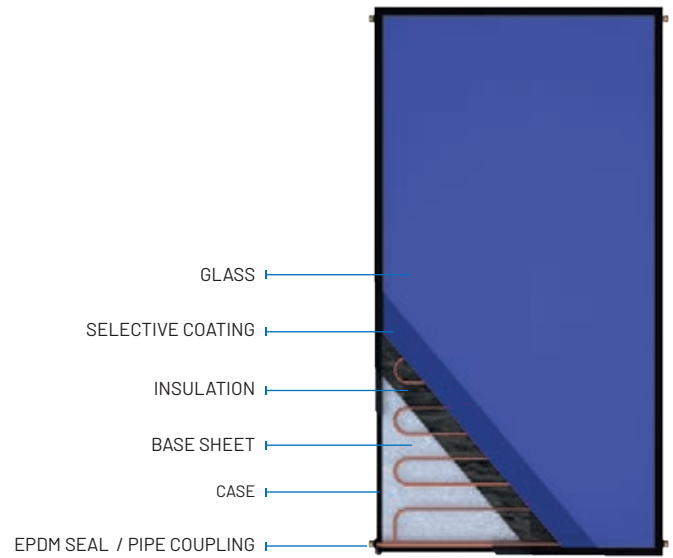
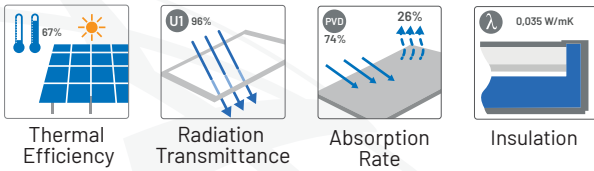

## Wunder ALS DRAIN

## Wunder ALS 2108 DRAIN

## Wunder ALS 2510 DRAIN

TECHNICAL DATA	Thermal efficiency(Ag)	%	71	71
	Thermal efficiency(Aa)	%	74	74
	Dimensions	mm	1988 X 1041 X 90	1988 X 1218 X 90
	Gross area	m <sup>2</sup>	2.07	2.42
	Absorber area	m <sup>2</sup>	1.93	2.27
	Weight empty	kg	29	33
	Absorber volume	L	1.67	2
	Max working pressure	bar	10	10
	Max operating temperature	°C	130	130
	Flow rate	kg/hm <sup>2</sup>	72	72
ABSORBER SURFACE	Plate Material		Highly Selective Aluminum	
	Absorptance	%	95	95
	Emittance	%	3	3
COPPER PIPE	Ø manifold pipe	mm	18	18
	Ø absorber pipe	mm	8	8
	Connection	inch	3/4"	3/4"
GLASS	Glass material		Low Iron Tempered Glass	
	Glass thickness	mm	3.2	3.2
INSULATION	Material		Rock Wool	Rock Wool
	Thickness	mm	40	40
	Density	kg/m <sup>3</sup>	50	50

# WUNDER ALS HORIZONTAL



- ✓ Solar Keymark certified
- ✓ Selective aluminum
- ✓ Rock wool insulation
- ✓ Copper pipe
- ✓ Low iron tempered glass
- ✓ Laser welding
- ✓ 10 years warranty

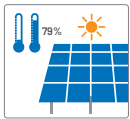

Thermal Efficiency

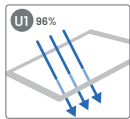

Radiation Transmittance

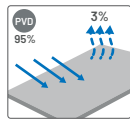

Absorption Rate

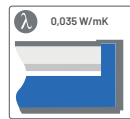

Insulation



EPDM SEAL / PIPE COUPLING

CASE

BASE SHEET

INSULATION

SELECTIVE COATING

GLASS



## Wunder ALS Horizontal

## Wunder ALS 2117 Horizontal

## Wunder ALS 2517 Horizontal

			Wunder ALS 2117 Horizontal	Wunder ALS 2517 Horizontal
TECHNICAL DATA	Thermal efficiency (Ag)	%	73	73
	Thermal efficiency (Aa)	%	79	79
	Dimensions	mm	1041 X 1988 X 90	1218 X 1988 X 90
	Gross area	m <sup>2</sup>	2.07	2.42
	Absorber area	m <sup>2</sup>	1.93	2.27
	Weight empty	kg	28.5	33
	Absorber volume	L	1.9	2.1
	Max working pressure	bar	10	10
	Max operating temperature	°C	130	130
	Flow rate	kg/hm <sup>2</sup>	72	72
ABSORBER SURFACE	Plate Material		Highly Selective Aluminum	
	Absorptance	%	95	95
	Emittance	%	3	3
COPPER PIPE	Ø manifold pipe	mm	18	18
	Ø absorber pipe	mm	8	8
	Connection	inch	3/4"	3/4"
	Number of pipe		17	17
GLASS	Glass material		Low Iron Tempered Glass	
	Glass thickness	mm	3.2	3.2
INSULATION	Material		Rock Wool	Rock Wool
	Thickness	mm	40	40
	Density	kg/m <sup>3</sup>	50	50

# EXCELLENT

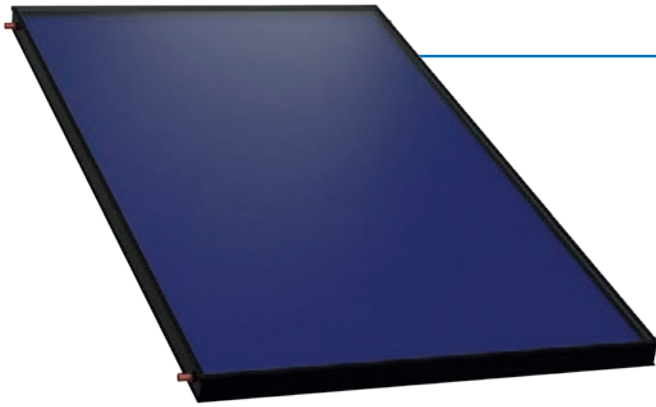

- Solar Keymark certified ✓
- Selective aluminum ✓
- Rock wool insulation ✓
- Copper pipe ✓
- Low iron tempered glass ✓
- Laser welding ✓
- 10 years warranty ✓

Thermal Efficiency

Radiation Transmittance

Absorption Rate

Insulation

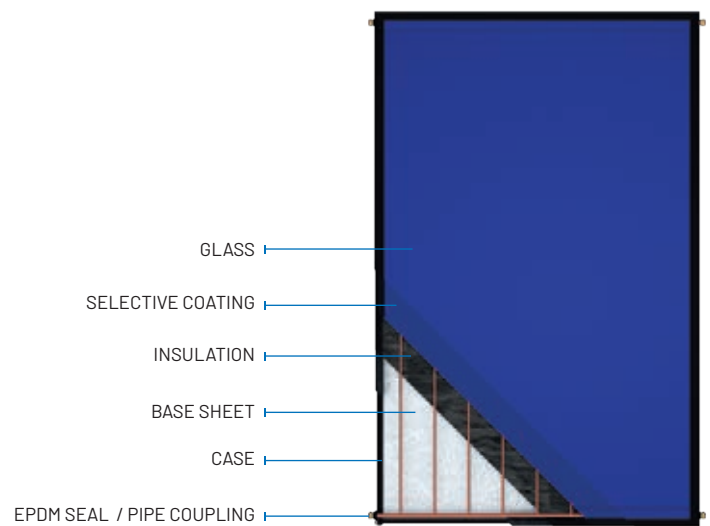

## EXCELLENT

## EXCELLENT 2.6

## EXCELLENT 2.3

			EXCELLENT 2.6	EXCELLENT 2.3
TECHNICAL DATA	Thermal efficiency (Ag)	%	79.4	79.4
	Thermal efficiency (Aa)	%	82	82
	Dimensions	mm	2013 X 1355 X 60	2012 X 2012 X 60
	Gross area	m <sup>2</sup>	2.59	2.4
	Absorber area	m <sup>2</sup>	2.46	2.28
	Weight empty	kg	40	36
	Absorber volume	L	1.61	1.41
	Max working pressure	bar	10	10
	Max operating temperature	°C	130	130
	Flow rate	kg/hm <sup>2</sup>	72	72
ABSORBER SURFACE	Plate Material		Highly Selective Aluminum	
	Absorptance	%	95	95
	Emittance	%	3	3
COPPER PIPE	Ø manifold pipe	mm	18	18
	Ø absorber pipe	mm	8	8
	Number of pipe		14	12
GLASS	Glass material		Low Iron Tempered Glass	
	Glass thickness	mm	3.2	3.2
INSULATION	Material		Glass Wool	Glass Wool
	Thickness	mm	15	15
	Density	kg/m <sup>3</sup>	50	50

# PV-T EXCELL 590 W

- ✓ Produces electricity and heat energy simultaneously.
- ✓ Integrated PV cooling system that increases electrical efficiency.
- ✓ 22% Electrical Efficiency + 43% Thermal Efficiency.
- ✓ Gross Area 2.7 m<sup>2</sup>.

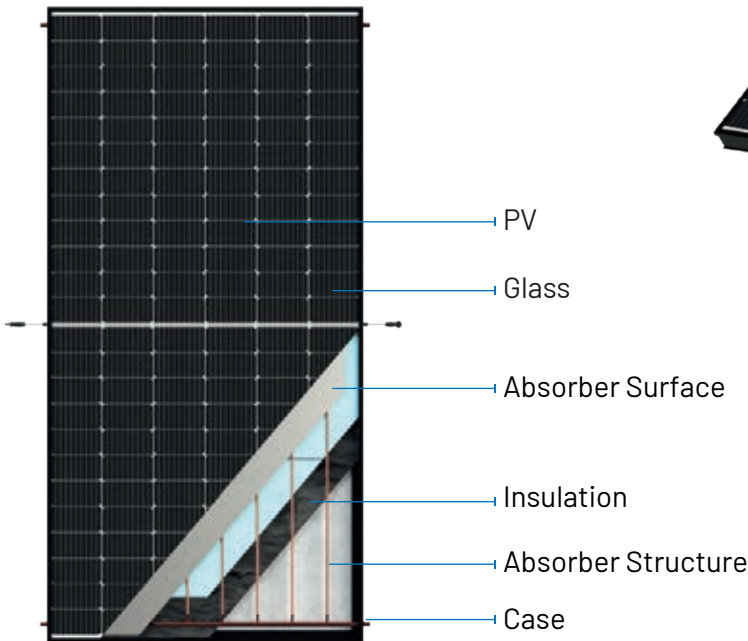
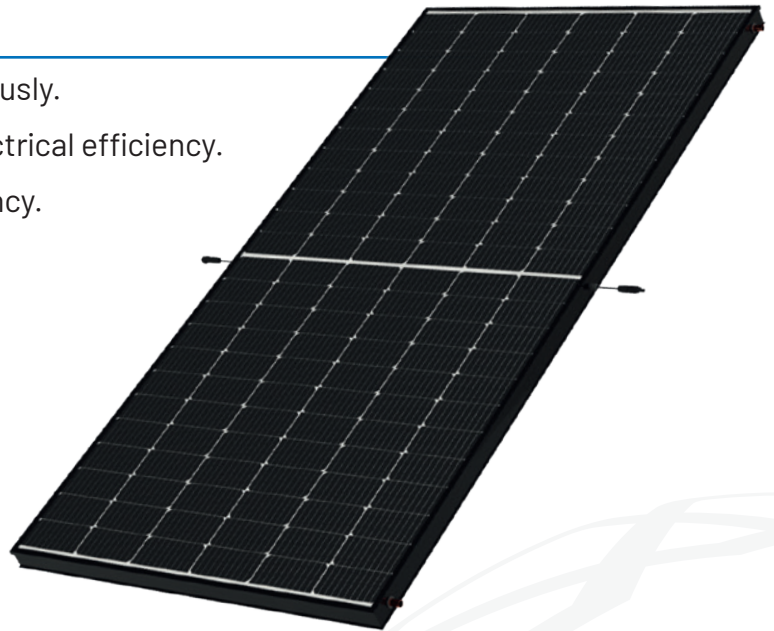

## PV-T EXCELL 590 W

Typical Electrical Parameters	
Peak Power Watts-PMAX (Wp)*	590
Power Tolerance Range-PMAX (W)	0~+5
Maximum Power Voltage-VMPP (V)	43,10
Maximum Power Current-IMPP (A)	13,69
Open Circuit Voltage-VOC (V)	51,72
Short Circuit Current-ISC (A)	14,44
Module Efficiency °m (%)	22,84
Maximum Power-PMAX (Wp)	439
Maximum Power Voltage-VMPP (V)	39,9
Maximum Power Current-IMPP (A)	11,00
Open Circuit Voltage-VOC (V)	48,39
Short Circuit Current-ISC (A)	11,77

STC: Irradiance 1000W/m<sup>2</sup>, Cell Temperature 25°C, Air Mass AM1.5.  
 \*Measuring tolerance: ±3%  
 NMOT: Irradiance at 800W/m<sup>2</sup>, Ambient Temperature 20°C, Wind Speed 1m/s.

Mechanical Parameters	
Solar Cells	Monocrystalline
Cell Orientation	144 cells (6 × 24)
Module Dimensions	2278×1134×35 mm (±0,1%)
Weight	28.KG
Front Glass	3,2 mm, High Transmission, AR Coated Heat Strengthened Glass
Encapsulant Material	POE/EVA
Back Glass	KPFTtype
Frame	35mm Anodized Aluminium Alloy
J-Box	IP 68 rated and 30cm or (optional 120cm cable)
Cables	Photovoltaic Technology Cable 4.0mm <sup>2</sup>
Connector	MC4 EVO2 / TS4

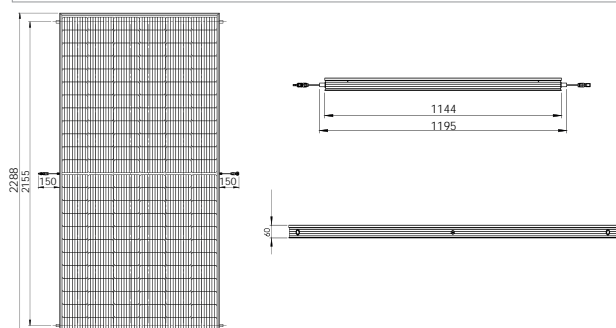

Specifications/Product Code	EXCELL PVT 590
Dimensions	2288x 1195 x 60mm
Weight	40 kg
Gross Area	2,7 m <sup>2</sup>
Number Of Cells	144
Nominal Power (Wp)	590 W
Glazing	Pv Glass
Absorber Surface (PV)	Mono
Absorber Surface (T)	Copper
Safety Class	II
Maximum over current protection rating	15A
Peak Power perunit QPeak= 1200 W (Kiwa Test Report No. L0000435/B rev.02. Page 20 di 23)	1200 W

# PVARM



## Advantages Compared to Solar Thermal Systems;

- ▶ Simple Installation: only two DC cables are needed, no water pipes.
- ▶ There is almost no loss between PV modules and hot water tank.
- ▶ Low Maintenance: no moving parts and no glycol.
- ▶ PV modules provide greater energy efficiency at low outdoor temperatures.
- ▶ There is no stagnation problem, it starts automatically if the hot water temperature is below the limit.

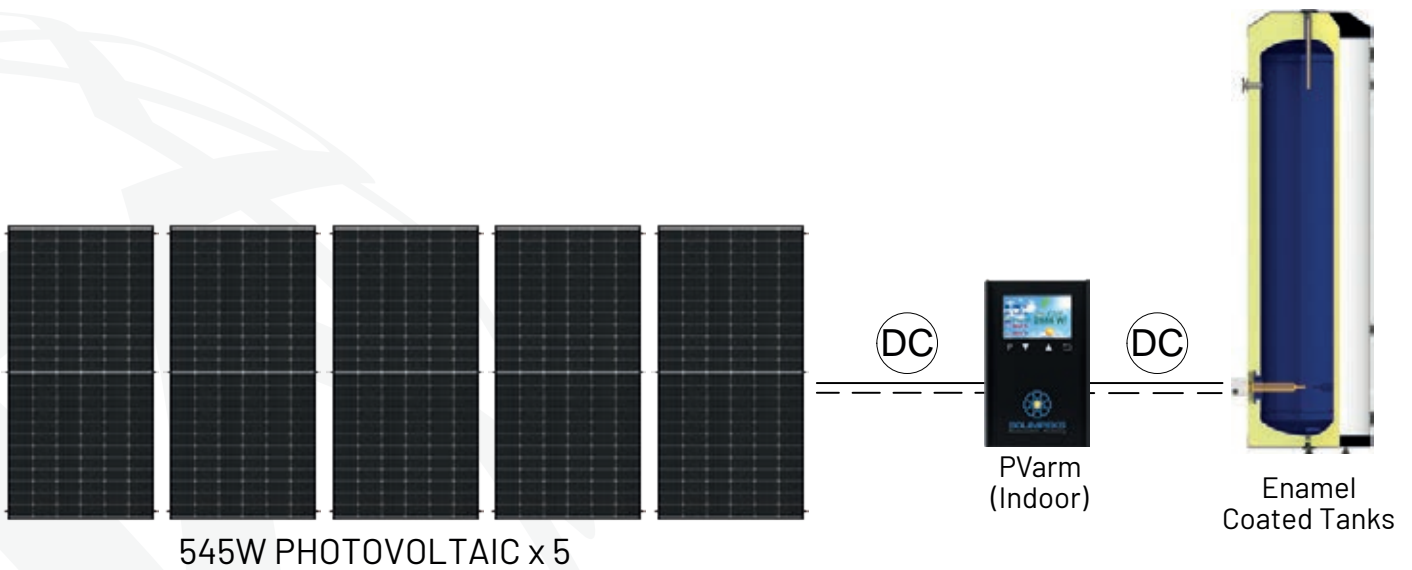

## PVarm

### DC

DC voltage = MPP voltage range	100 - 360 V (max)
Number of MPP trackers	1
Max. input current	13 A, limited
DC nominal power	2.750 W at 25 °C ambient temperature, built-in derating

### GENERAL DATA

MPP-efficiency	98,50%
Total efficiency	>98 % at nominal power
Protection class	IP20
Operating temperature range	10 °C to 45 °C
Display	2.8 inch IPS
Dimensions	145 x 110 x 50 mm
Weight	0.8 kg
Warranty	1 years

# VARM UP

## VARM UP SERIES

- ✓ The Varm Up Series EVI DC Inverter heat pumps efficiently meet heating, cooling, and hot water needs. With R32 refrigerant and EVI technology, they operate reliably down to -30°C.
- ✓ Thanks to Wi-Fi and IoT support, the system can be easily controlled remotely. The 0.1°C temperature precision and colorful LCD panel provide a user-friendly experience. With high COP and SCOP values, it ensures excellent energy efficiency. Its durable design guarantees long-lasting performance.
- ✓ The Varm Up Series combines comfort, innovation, and efficiency.

-30°C Operating Temperature

IoT Cloud Platform

High SCOP Values

Remote Control via WiFi

Heating & Cooling DHW Mode

Panasonic Compressor



Varmeks Model		VM-OMB1112008	VM-OMB1112013	VM-OMB1112016	VM-OMB1112018	VM-OMB3112023	VM-OMB3112028	VM-OMB3112035
Power Supply		230V/1Ph/50-60Hz	230V/1Ph/50-60Hz	230V/1Ph/50-60Hz	230V/1Ph/50-60Hz	380V/3Ph/50-60Hz	380V/3Ph/50-60Hz	380V/3Ph/50-60Hz
Circulation Pump		Shimge DC Pump	Shimge DC Pump	Shimge DC Pump	Shimge DC Pump	Shimge DC Pump	AWMT	AWMT
Heating	Heating Capacity Range (kW)	1.57-8.40	4.40-13.00	5.8-15.5	5.9-18.2	7.5-23.0	10.2-28.0	12.8-35.0
	Heating Input Range (kW)	0.32-1.87	0.90-3.02	1.22-3.66	1.20-4.11	1.61-5.38	2.17-6.56	2.71-8.19
	Current Range (A)	1.42-8.30	4.12-13.8	5.58-16.57	5.49-18.8	4.23-14	5.71-17.50	7.13-21.55
	COP Range	4.49-4.91	4.30-4.90	4.23-4.75	4.43-4.92	4.28-4.66	4.27-4.70	4.27-4.72
Cooling	Cooling Capacity Range (kW)	0.99-6.22	2.80-8.20	5.5-11.0	3.81-11.53	4.73-14.6	6.54-19.8	8.13-24.6
	Cooling Input Power (kW)	0.29-2.18	0.85-3.31	1.67-3.99	1.11-4.05	1.47-5.29	2.02-7.17	2.52-8.95
	Current Range (A)	1.28-9.67	3.89-15.1	7.64-18.26	5.08-18.5	3.86-13.9	5.31-18.86	6.63-23.55
	EER Range	2.85-3.41	2.48-3.29	2.76-3.29	2.85-3.43	2.76-3.22	2.76-3.24	2.75-3.23
DHW	Heating Capacity Range (kW)	1.28-6.81	3.52-10.50	8.2-13.6	4.80-14.72	6.1-18.5	12.3-20.4	13.6-22.6
	Heating Input Range (kW)	0.31-2.13	0.88-3.39	1.91-3.68	1.17-4.60	1.61-6.12	2.9-5.57	3.19-6.15
	Current Range (A)	1.38-9.45	4.03-15.5	8.74-16.74	5.35-21.1	4.23-16.1	7.63-14.65	8.39-16.18
	COP Range	3.2-4.1	3.1-4.0	3.7-4.3	3.2-4.1	3.0-3.7	3.6-4.2	3.6-4.2
Refrigerant		R32 (GWP only 1/3 of R410a)						
Working Area		-30~43 °C						
Water Circulation (m³/h)		1,4	2,2	2,7	3,1	3,9	4,8	6,0
Water Pressure Drop (kPa)		31	25	35	35	45	50	55
IP Grade (Level of Protection)		IPX4	IPX4	IPX4	IPX4	IPX4	IPX4	IPX4
Anti-Electric Shock Rate		I	I	I	I	I	I	I
Noise dB(A) at 1m		≤53	≤55	≤57	≤57	≤57	≤59	≤59
Net Weight/Gross Weight (kg)		110/120	140/150	135/145	170/180	165/175	220/230	240/250
Diameter of Pipe (mm)		DN25	DN25	DN25	DN25	DN25	DN32	DN32
Body Size (W*D*H)(mm)		970×475×835	1100×475×985	1080×480×1060	1050×480×1330	1050×480×1380	1160×500×1580	1160×500×1580
Packing Size (W*D*H) (Carton)		1028×520×974	1120×515×1108	1100×490×1210	1100×530×1470	1100×490×1510	1200×510×1720	1200×510×1720
Packing Size (W*D*H) (Polywood)		1048×520×974	1140×515×1110	1140×520×1220	1120×530×1470	1120×520×1520	1230×540×1730	1230×540×1730
Compressor Brand		Panasonic						
Four-Way Valve		Sanhua						
Expansion Valve		Sanhua						
Operating Water Temp. (°C) DHW		9-60 °C		28-55 °C		9-60 °C		28-55 °C
Operating Water Temp. (°C) Heating		9-55 °C		15-55 °C		9-55 °C		15-55 °C
Operating Water Temp. (°C) Cooling		7-35 °C		7-30 °C		7-35 °C		7-30 °C

Testing condition: Heating: Inlet water temp. 30 °C, Outlet water temp. 35 °C, Dry bulb temp. 7 °C, Wet bulb temp. 6 °C. Cooling: Inlet water temp. 12 °C, Outlet water temp. 7 °C, Dry bulb temp. 35 °C, Wet bulb temp. 24 °C. HW: Inlet water temp. 15 °C, Outlet water temp. 55 °C, Dry bulb temp. 7 °C, Wet bulb temp. 6 °C.

# VARM SILENT POOL SERIES

- ✓ The Varm Silent Pool heat pump can heat from  $-7^{\circ}\text{C}$  to  $40^{\circ}\text{C}$  and cool the pool water down to  $9^{\circ}\text{C}$  in the summer. Its ABS plastic casing is corrosion-resistant and suitable for pools ranging from  $15\text{ m}^3$  to  $100\text{ m}^3$ .
- ✓ With Smart Life integration, it can be controlled remotely. The high COP value ensures energy efficiency.
- ✓ The Varm Silent Pool Heat Pump offers an excellent pool heating solution with its durability, energy efficiency, and ease of use.



$-7^{\circ}\text{C}$  Operating Temperature



IoT Cloud Platform



High COP Values



Remote Control via WiFi



Panasonic Compressor



$9^{\circ}\text{C}$  Cooling  
 $40^{\circ}\text{C}$  Pool Heating



Varmeks Model	VM-0P01102010	VM-0P01102011	VM-0P01102014	VM-0P01102017	VM-0P01102020	VM-0P01102024	VM-0P01102028	VM-0P01102033
Advised Pool Volume (m <sup>3</sup> )	20-40	25-50	30-60	40-75	55-100	70-130	60-120	70-130
Operating Air Temperature (°C)	-7 ~ 43 °C							
Performance Condition: Air 27 °C, Water 26 °C, Humidity 80%								
Heating Capacity (kW)	9.50-2.10	11.00-2.50	14.00-3.15	17.00-3.75	20.00-4.00	24.00-4.80	28.00-5.60	32.50-6.50
Heating Capacity (Btu)	32300-7140	37400-8500	47600-10710	57800-13090	68000-13600	81600-16320	95500-19100	110900-22100
Consumed Power (kW)	1.46-0.14	1.83-0.17	2.15-0.21	2.62-0.25	3.33-0.27	4.00-0.32	4.75-0.37	5.42-0.43
COP	6.5-15.0	6.0-14.7	6.5-15.0	6.5-15.0	6.0-14.8	6.0-15.0	6.0-15.0	6.0-15.0
COP at 50% Capacity	11,00	11,00	10,50	11,00	11,00	11,00	11,00	11,00
Performance Condition: Air 15 °C, Water 26 °C, Humidity 70%								
Heating Capacity (kW)	7.2-1.50	8.5-1.65	10.7-2.40	13.0-2.65	15.6-2.85	18.7-3.42	21.8-4.36	25.4-5.07
Heating Capacity (Btu)	24480-5100	28900-5610	36380-8160	44200-9010	53040-9690	63580-11630	74380-14880	86665-17300
Consumed Power (kW)	1.43-0.21	1.77-0.23	2.12-0.34	2.58-0.36	3.25-0.40	3.89-0.49	4.54-0.62	5.29-0.72
COP	5.0-7.2	4.8-7.2	5.0-7.1	5.0-7.4	4.8-7.0	4.8-7.0	4.8-7.0	4.8-7.0
COP at 50% Capacity	6,50	6,50	6,50	6,50	6,50	6,50	6,50	6,50
Performance Condition: Air 35 °C, Water 28 °C, Humidity 80%								
Cooling Capacity (kW)	5,2	6,0	7,2	8,6	10,1	11,8	13,8	15,6
Sound Pressure at 1m dB(A)	38-48	40-50	42-51	43-52	43-53	44-54	45-56	45-57
Sound Pressure of 50% Capacity at 1m dB(A)	40	41	43	44	44	45	48	49
Sound Pressure at 10m dB(A)	18-25	19-26	22-27	23-30	24-31	25-32	26-34	26-35
Heat Exchanger	Spiral Titanium Tube in PVC							
Casing	ABS Plastic Casing							
Refrigerant	R32							
Power Supply	230V/1 Ph/50Hz							
Compressor	Panasonic							
Four-way Valve	Sanhua							
Expansion Valve	Sanhua							
Operating Water Temperature (°C)*heating	9 ~40							
Operating Water Temperature (°C)*cooling	9 ~35							
Water Connection (mm)	Ø50							
Rated Input Current at Air 15°C (A)	6.3-0.9	7.8-1.0	9.3-1.5	11.3-1.6	14.3-1.8	17.8-2.3	20.8-2.8	24.2-3.3
Advised Water Flux (m <sup>3</sup> /h)	2-4	3-5	4-6	6-9	8-10	9-12	10-14	12-16
Water Pressure Drop (max) kPa	3	4	5	5	6	8	20	25
Net Weight/Gross Weight (kg)	62/70	64/72	77/87	81/91	81/91	95/105	110/122	115/127
Product Size (mm)	1000*396*640			1125*416*765			1156*430*905	
Packaging Size (mm) (Carton)	1040*410*780			1165*430*905			1230*440*1030	

\*Installation should be done with PVC pipe.

# VARM ALL SERIES

- ✓ The Varm All Series Heat Pump provides domestic hot water using ambient air. With a corrosion-resistant anode rod, it ensures the durability of the tank. High-density polyurethane (PU) foam insulation reduces heat loss, while the ABS casing contributes to its longevity.
- ✓ Operating at a low noise level (48 dB(A)), the heat pump is equipped with a high-efficiency compressor and R134A refrigerant. It provides hot water up to 75°C and includes an external electric heater. The unit features electronic expansion valve control and a next-generation digital display for easy monitoring. The interior surfaces of the tank are coated with advanced enamel technology for added durability.
- ✓ With high COP values, the Varm All Series ensures reliable and energy-efficient performance.



75°C  
Hot Water



High COP  
Values



Remote Control  
via WiFi



Smart  
Defrost



With External  
Electric Heater

Varmeks Model		VARM ALL 300	VARM ALL 200	VARM ALL 150
Power Source	V/Ph/Hz	220-240/1/50	220-240/1/50	220-240/1/50
Water Tank Real Capacity	L	286	197	149
Heating Capacity	W	2400* (+2000**)	2400* (+2000**)	2400* (+2000**)
Rated Power Input	W	585* (+2000**)	585* (+2000**)	585* (+2000**)
Rated Current	A	3* (+9.3**)	3* (+9.3**)	3* (+9.3**)
COP	W/W	4.1	4.1	4.1
Maximum Power Input	W	1000 (+2000**)	1000 (+2000**)	1000 (+2000**)
Maximum Current	A	5 (+9.3**)	5 (+9.3**)	5 (+9.3**)
Max. Output Water Temperature (Without Using E-heater)	°C	75	75	75
Refrigerant	-	R134A	R134A	R134A
Waterproof Level	-	IPX1	IPX1	IPX1
Maximum Allowable Tank Pressure	bar	10	10	10
Auxiliary Electric Heater	kW	2	2	2
Electronic Expansion Valve		Yes	Yes	Yes
Cold Water Inlet	inch	3/4"	3/4"	3/4"
Hot Water Outlet	inch	3/4"	3/4"	3/4"
Auxiliary Heat Source Input/Output	inch	1 1/4"	1 1/4"	1 1/4"
Net Dimensions	mm	φ760x1900	φ760x1550	φ640x1525
Net Weight	kg	118	108	90

# ACCESSORIES



Pump Station  
TI-0131 and TI-0129



Solar Controller  
TI-0209 and TI-0210



Expansion Vessel  
TI-0531



Air Purger  
HA -1498

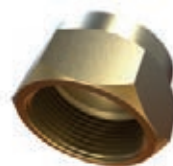

End Cap  
HA - 0345



Flexible Connection  
YA - 0215



Electrical Heater  
Thermostat  
TI-0079 and TI-0080



Sensor Set  
TI-0315



End Fittings Pack



**SOLIMPEKS**  
Renewable Energy

**SOLIMPEKS SOLAR ENERGY CORP.**

Solimpeks Headquarters  
Fevzi Çakmak Mah. 10753. Sk. No: 3  
Karatay / Konya / TURKEY  
Tel: +90 332 346 3841  
Fax: +90 444 06 08  
E-Mail: info@solimpeks.com  
[www.solimpeks.com](http://www.solimpeks.com)

**SOLIMPEKS PAZ. MÜH. LTD. ŞTİ.**

Meriç Mah. 5627 Sok. No:10 35090  
Çamdibi – Bornova / İZMİR  
(Renoto Renault Servis Yan Sokağı)  
Tel : +90 232 472 26 66  
Fax : +90 232 457 08 58  
E-Mail: info@solimpeks.com.tr  
[www.solimpeks.com.tr](http://www.solimpeks.com.tr)

**SOLIMPEKS SOLARENERGIE GmbH**

Hagenbleckstr. 50  
30455 Hannover / GERMANY  
Tel: +49 (0) 89 59 08 23 24  
Fax: +49 (0) 89 59 08 12 00  
E-Mail: info@solimpeks.de  
[www.solimpeks.de](http://www.solimpeks.de)

Solimpeks Solar Solimpeks Solimpeks Company / Solimpeks

Information may be changed or updated without notice. Solimpeks may also make improvements and/or changes\*  
\*in the products, specifications and/or the certificates described in the catalog at any time without notice



[solimpeks.com](http://solimpeks.com)

07.2025/2